

CATALOGUE

Collection 2026



Plantez votre décor pour des instants mémorables

Set the scene for memorable moments

Look Book

















Travailler avec passion
Work with passion















L'excellence sur mesure
Tailor-made excellence











Tentes & Structures

TENTS & STRUCTURES

Voyez plus grand
Think bigger

Également disponible à la vente
Also available for sale

Collection
TENTE NOMADE
NOMADIC STRETCH TENT COLLECTION

« La couverture parfaite »
« The perfect cover »

LÉGENDE
KEY



Anti UV
UV protection



990 g/m²
990 g / m²



Étanche
Waterproof

CTS

Homologué
Certified



100 km/h de vent
100 km/h wind



Ignifugé M2
Fireproof M2



4 cm de neige
4 cm of snow

Tente Nomade
Nomadic stretch tent



Tente Nomade

Nomadic stretch tent

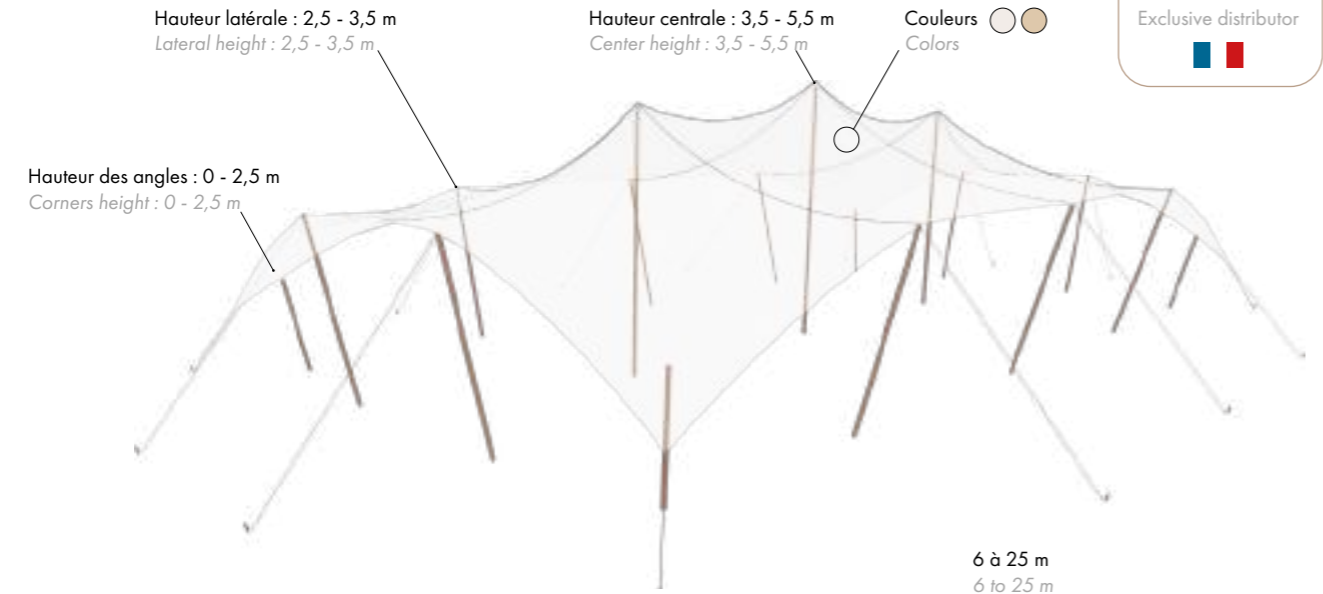

☀️ ✨ ☔ **CTS**

Capacité
Capacity

1 à 1,5 m²/p
1 to 1,5 m²/p

Jumelage possible
Possible twinning

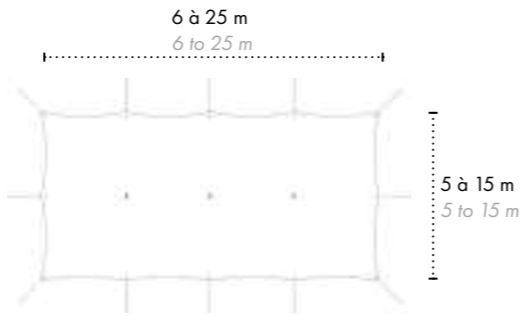

- Toile stretch 4 couches
- Mâts périphériques eucalyptus
- Mâts centraux aluminium habillage beige
- Adaptée à tous types de terrains
- Tailles disponibles : de 30 m² à 375 m² d'un seul tenant
- 4 layers stretch canvas
- Eucalyptus peripheral poles
- Chino covering aluminium center poles
- Suitable for all types of ground
- Available sizes : from 30 m² to 375 m² in one piece

ARRIMAGE STOWAGE

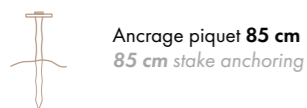

Le montage classique d'une tente nomade nécessite un **ancrage par piquets**. Si le sol ne le permet pas, des lestés seront nécessaires. Il convient également de prévoir **2 m supplémentaires** de chaque côté de la tente, ainsi qu'un **espace dégagé**.

Conventional set ups of stretch tent require **stakes to be used as anchors**. If the ground does not allow this, weights will be needed. You should also allow an extra **2 m** on each side of the tent, as well as a **clear space**.

OPTION

HABILLEZ L'INTÉRIEUR DE VOTRE TENTE NOMADE DRESS UP THE INSIDE OF YOUR NOMADIC STRETCH TENT

- Une toile lycra «seconde peau» pour l'intérieur d'une tente nomade
- Modèle "Jungle" disponible en 10 x 20 m
- **Consultez-nous pour une création sur-mesure**
- A "second skin" lycra fabric for the inside of the nomadic tent
- "Jungle" model available in 10 x 20 m
- **Contact us for a custom-made design**



MONTAGES POSSIBLES POUR TOUTES LES TENTES NOMADES POSSIBLE SET-UPS FOR ALL NOMADIC STRETCH TENTS

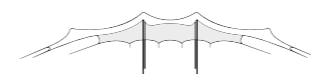

Air



4 x 4

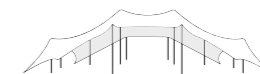

Open

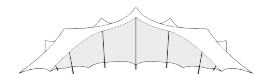

Pavillon

Tente Nomade
Nomadic stretch tent



Tente Nomade Octogonale

Octagonal Nomadic stretch tent

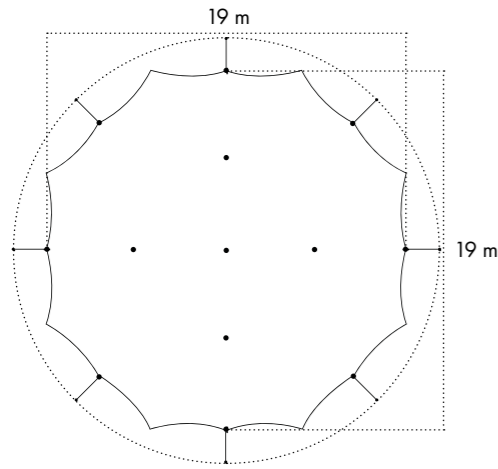

PETITE SOEUR
LITTLE SISTER

290 m²

∅ 19 m / Hauteur : 4,50 m Height : 4,50 m

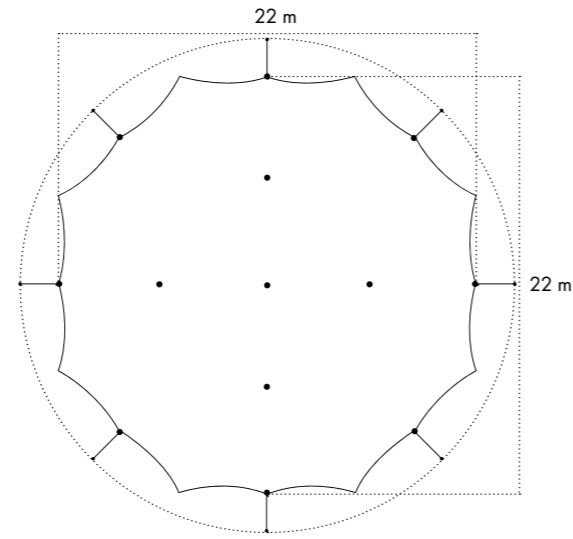

GRANDE SOEUR
BIG SISTER

380 m²

∅ 22 m / Hauteur : 5,50 m Height : 5,50 m

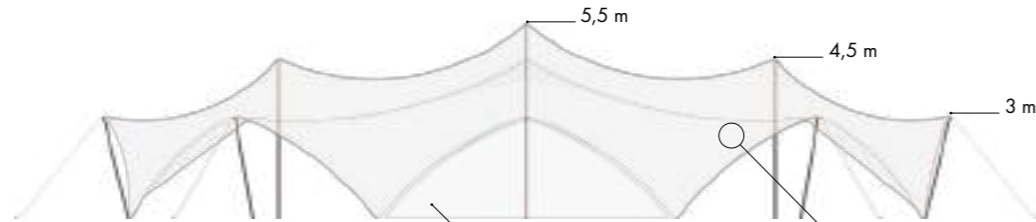

☀	❄	☔	CTS
Capacité Capacity	👤	1,5 m ² /p	

Parois en option, vitrées ou opaques
Optional walls, glazed or opaque

Couleurs
Colors

ARRIMAGE STOWAGE



Ancrage piquet 85 cm
85 cm stake anchoring



Lestage béton par hauban
Concrete ballast per pole
1 - 2 t

Le montage classique d'une tente nomade octogonale nécessite un **ancrage par piquets**. Si le sol ne le permet pas, des lests seront nécessaires. Il convient également de prévoir **2 m supplémentaires** de chaque côté de la tente, ainsi qu'un **espace dégagé**.

Conventional set ups of octagonal stretch tent require **stakes to be used as anchors**. If the ground does not allow this, weights will be needed. You should also allow an extra **2 m on each side of the tent**, as well as a **clear space**.

Retrouvez tous les attributs de notre tente nomade combinés en une forme octogonale. De plus, ses 8 angles au sol garantiront une robustesse accrue. Sa forme originale est certes plus exigeante en matière d'espace disponible, mais elle donnera à votre événement une dimension toute aussi majestueuse.

All the attributes of our nomadic tent combined in an octagonal shape. Moreover, its 8 angles to the ground will guarantee extra sturdiness. Its original shape may require more space, but it will give your event an equally majestic dimension.



Également disponible à la vente
Also available for sale

Collection
ORANGERIE NOMADE
SAILCLOTH TENT COLLECTION

« Protégez ce qui est précieux »
« Protect what's precious »

LÉGENDE
KEY



Anti UV
UV protection



700 g/m²
700 g / m²



Étanche
Waterproof

CTS

Homologué
Certified



100 km/h de vent
100 km/h wind



Ignifugé M2
Fireproof M2



4 cm de neige
4 cm of snow

Orangerie Nomade
Sailcloth tent



Orangerie Nomade

Sailcloth tent

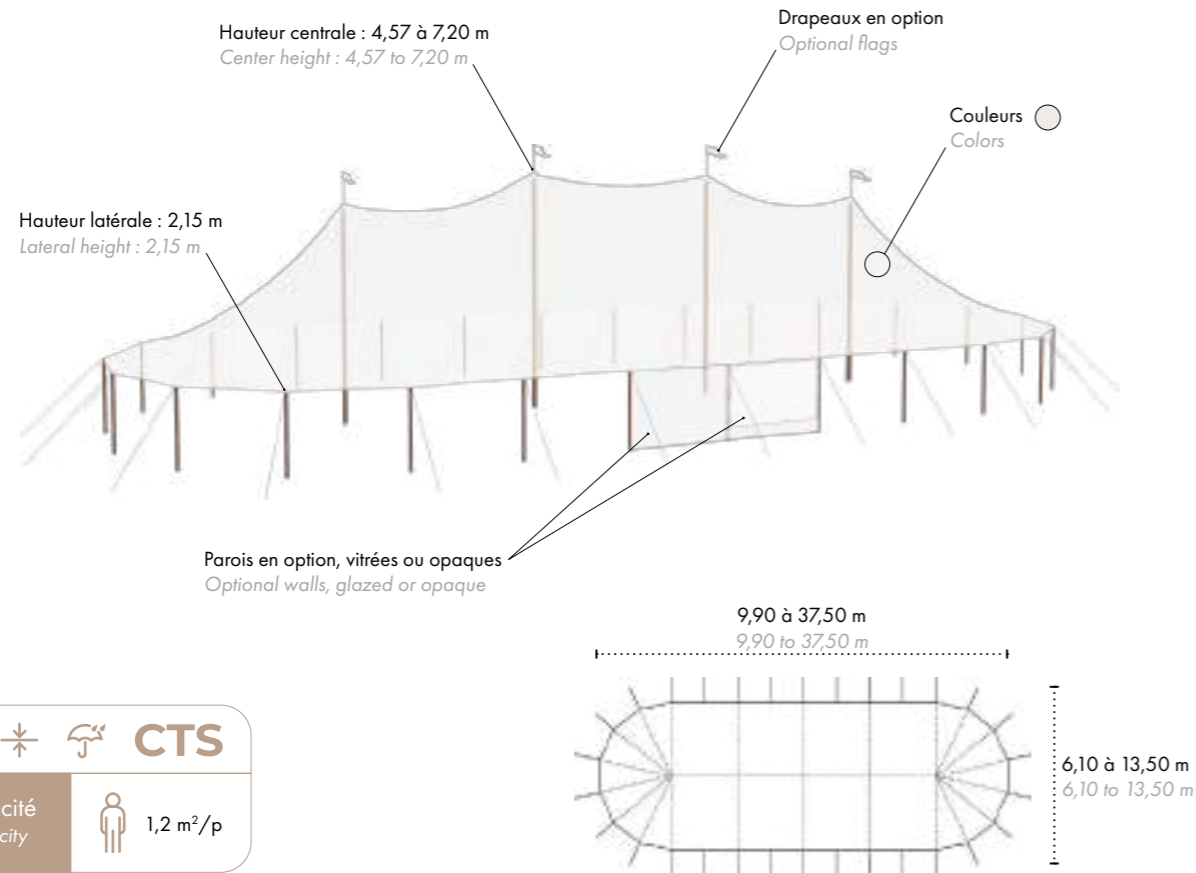

- Toile inspirée de la voilerie américaine
- Mâts au choix : bois pin massif ou aluminium habillé
- Entièrement fermable avec ses parois en PVC souples
- Forme ovale originale
- Chauffage en option

- Canvas inspired by American sailmaking
- Poles choice : solid pin wood or dressed aluminium
- Fully closable with flexible PVC walls
- Original oval shape
- Optional heating

ARRIMAGE STOWAGE

 Ancrage piquet 85 cm
85 cm stake anchoring

 Lestage béton par hauban
Concrete ballast per pole
1-2 t

Le montage d'une orangerie nomade nécessite un **ancrage par piquets**, toutefois, si le sol ne le permet pas, des lests seront nécessaires. Il convient également de prévoir **2 m supplémentaires** de chaque côté de la tente, ainsi qu'un **espace dégagé**.

Conventional set ups of sailcloth tent require **stakes to be used as anchors**, but if the ground does not allow this, ballast weights will be required. You should also allow an extra **2 m on each side of the tent**, as well as a **clear space**.



MODÈLE DE LARGEUR 6,10 M
6.10 M WIDE MODEL

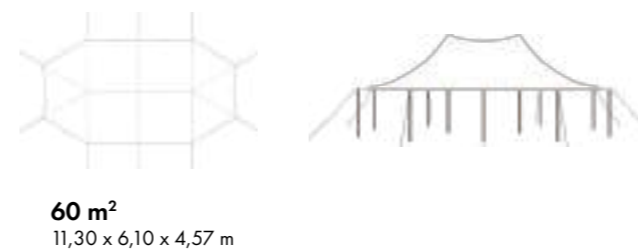

Idéale pour votre réception en **intimité** ou en **office traiteur** à relier à votre espace, grâce à notre structure de connexion.

Ideal for intimate receptions or as a catering office to be connected to your space, thanks to our connection structure.

Orangerie Nomade
Sailcloth tent



MODÈLE DE LARGEUR 9,90 M
9.90 M WIDE MODEL



70 m²
9,40 x 9,90 x 5,48 m

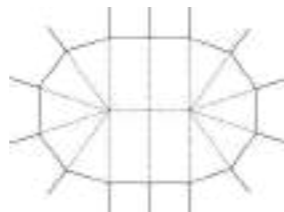

130 m²
15,30 x 9,90 x 5,48 m

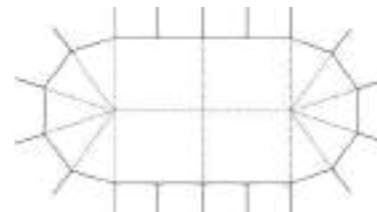
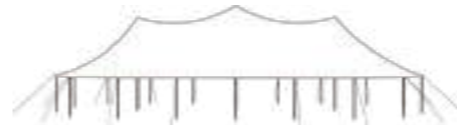

190 m²
21,20 x 9,90 x 6,13 m



250 m²
27,10 x 9,90 x 6,13 m

Orangerie Nomade
Sailcloth tent



MODÈLE DE LARGEUR 13,50 M
13.50 M WIDE MODEL

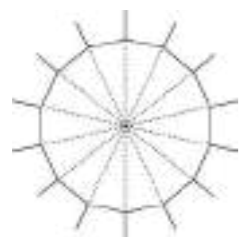

140 m²
13,50 x 13,50 x 6,40 m

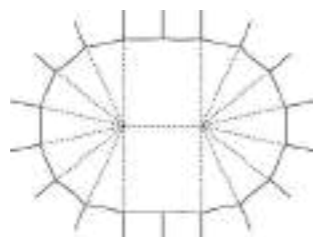

220 m²
19,20 x 13,50 x 6,40 m

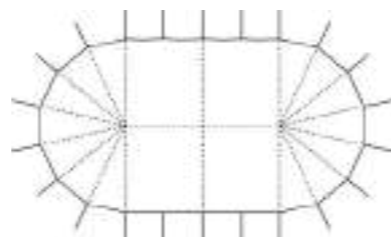
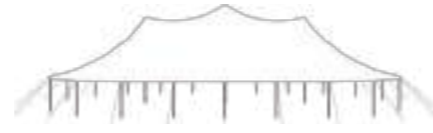

310 m²
25,50 x 13,50 x 7,30 m

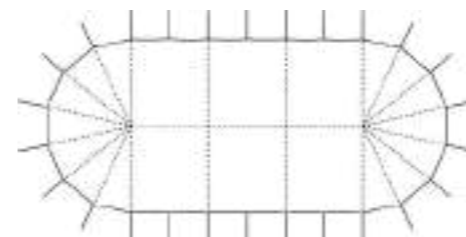
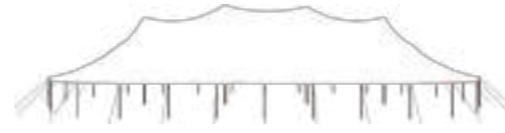

390 m²
31,10 x 13,50 x 7,30 m

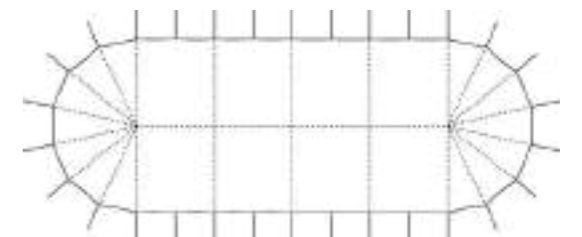
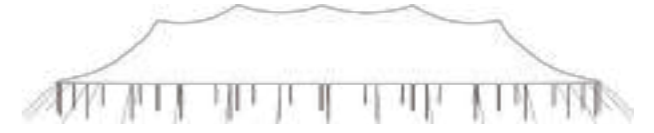

470 m²
37,50 x 13,50 x 7,30 m

Collection

ORANGERIE ABYSSALE

« ABYSSAL » SAILCLOTH TENT COLLECTION

« L'espace, c'est le luxe absolu »
« Space is the ultimate luxury »

LÉGENDE
KEY



Anti UV
UV protection



700 g/m²
700 g / m²



Étanche
Waterproof

CTS

Homologué
Certified



100 km/h de vent
100 km/h wind



Ignifugé M2
Fireproof M2



4 cm de neige
4 cm of snow

Orangerie Abyssale
«Abyssal» sailcloth tent



Orangerie Abyssale

«Abyssal» sailcloth tent

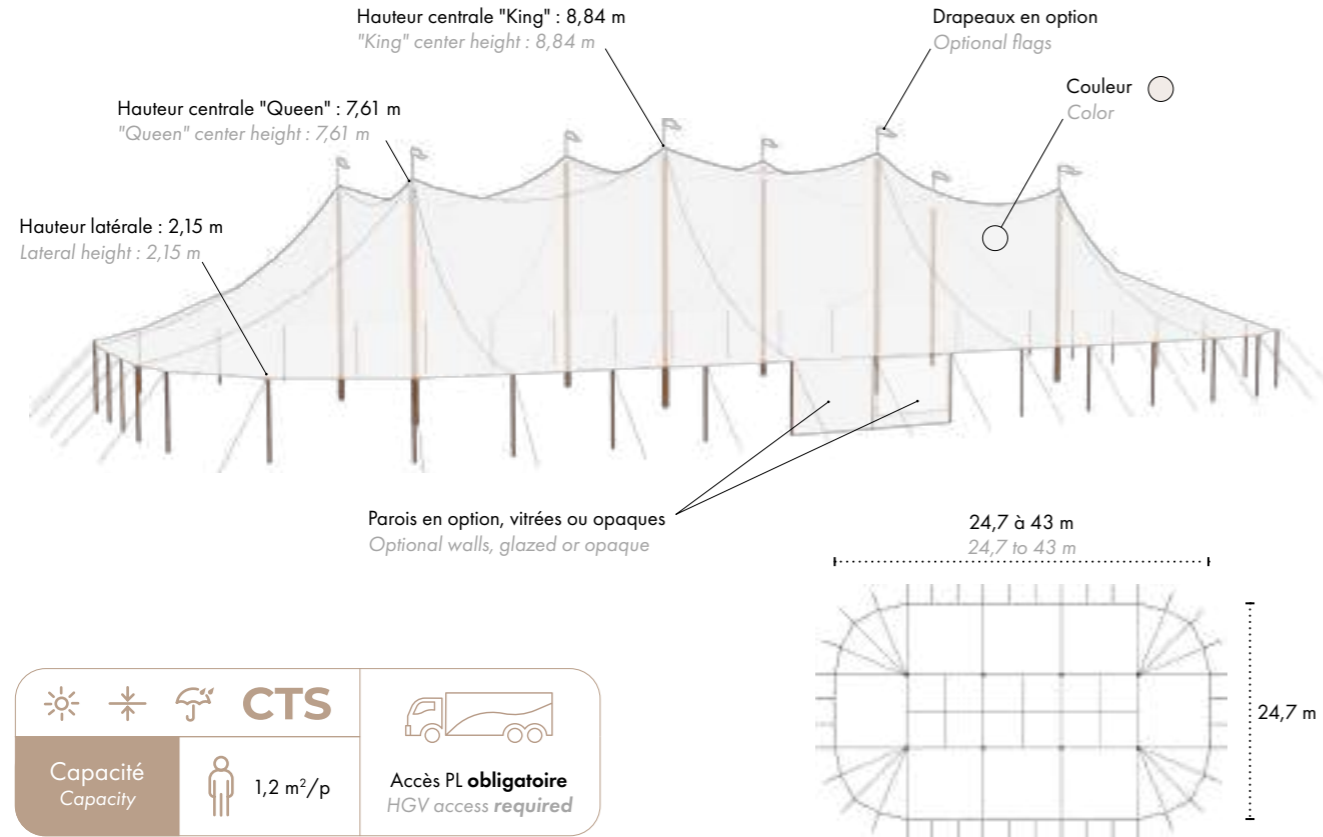

- Notre plus grande structure jusqu'à 1025 m²
- Toile inspirée de la voilerie américaine
- Immense hauteur sous plafond (8,84 m)
- Mâts au choix : bois pin massif ou aluminium habillé
- Entièrement fermable avec ses parois en PVC souple
- Forme originale
- Chauffage en option

- Our largest structure up-to 1025 m²
- Canvas inspired by American sailmaking
- Immense ceiling height (8,84 m)
- Poles choice : solid pin wood or dressed aluminium
- Fully closable with flexible PVC walls
- Original shape
- Optional heating

ARRIMAGE STOWAGE



Ancrage piquet 115 cm
115 cm stake anchoring

Le montage d'une orangerie abyssale nécessite impérativement un **ancrage par piquets**. Il convient également de prévoir **2 m supplémentaires** de chaque côté de la tente, ainsi qu'un **espace dégagé**.

Conventional set ups of "abyssal" sailcloth tent **must be anchored with stakes**. You should also allow an extra **2 m on each side of the tent**, as well as a **clear space**.



Orangerie Abyssale

«Abyssal» sailcloth tent

ORANGERIE ABYSSALE 575 M²
575 M² «ABYSSAL» SAILCLOTH TENT

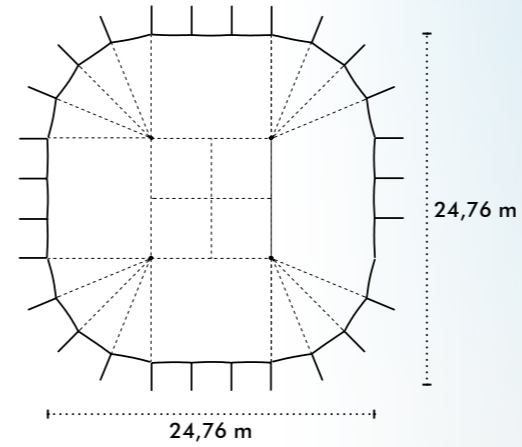

ORANGERIE ABYSSALE 800 M²
800 M² «ABYSSAL» SAILCLOTH TENT

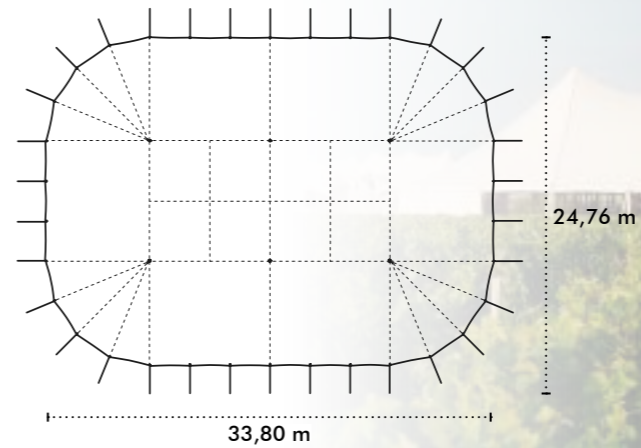

ORANGERIE ABYSSALE 1025 M²
1025 M² «ABYSSAL» SAILCLOTH TENT

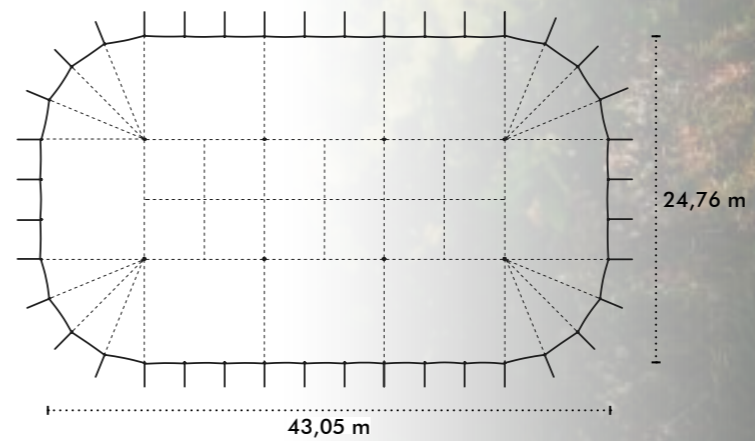

Orangerie Abyssale
«Abyssal» sailcloth tent



Également disponible à la vente
Also available for sale

Collection
TENTE VERRIÈRE
« VERRIÈRE » STRUCTURE COLLECTION

« En toute transparence »
« In full transparency »

LÉGENDE
KEY



Anti UV
UV protection



Étanche
Waterproof

CTS

Homologué
Certified



100 km/h de vent
100 km/h wind



Ignifugé M2
Fireproof M2



4 cm de neige
4 cm of snow



Tente Verrière
«Verrière» structure

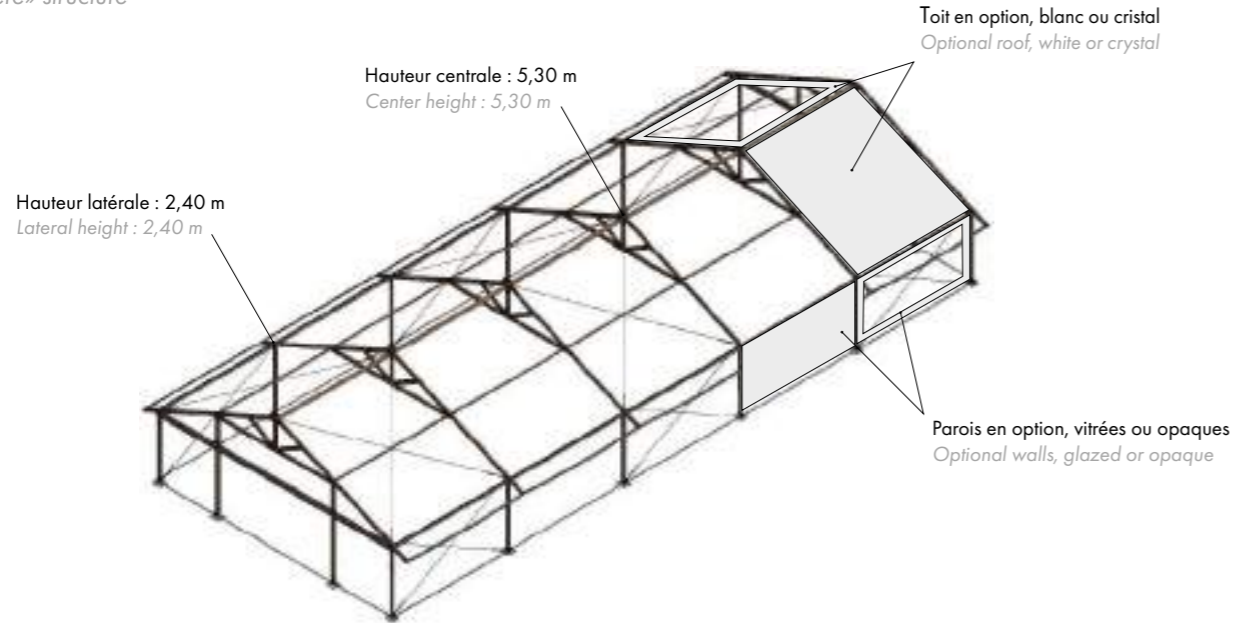

Tente Verrière

«Verrière» structure



☀️ ☂️ CTS	
Capacité Capacity	Accès PL obligatoire HGV access required
 1,2 m ² /p	

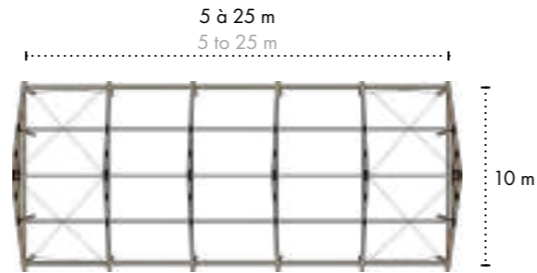

- Fabrication française
- Structure autoportée
- Ossature aluminium thermolaquée, effet bois
- Entièrement fermable, toit et parois en PVC souple
- Lumineuse grâce à sa transparence totale
- Chauffage en option
- French manufacture
- Self-supporting structure
- Powder-coated aluminium structure, wood effect
- Fully closable, flexible PVC roof and walls
- Bright thanks to its total transparency
- Optional heating

ARRIMAGE STORAGE



Le montage d'une tente verrière nécessite un **ancrage par piquets**, toutefois, si le sol ne le permet pas, des lests seront nécessaires.

Conventional set ups of "verrière" tent require **stakes to be used as anchors**, but if the ground does not allow this, ballast weights will be required.



ASSEMBLAGE DE MODULE DE 50 À 250 M² MODULE ASSEMBLY FROM 50 TO 250 M²

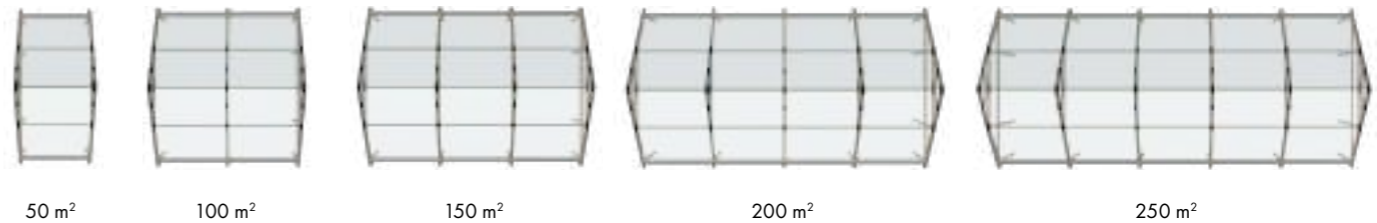

Tente Verrière
"Verrière" structure



Collection
GRAND PALAIS VITRÉ
GREENHOUSE « GRAND PALAIS » COLLECTION

« Harmonie sous verre »
« Harmony under glass »

LÉGENDE
KEY



Ventilation
Ventilation



Anti UV
UV protection



Étanche
Waterproof



Clim réversible
A/C

CTS

Homologué
Certified



100 km/h de vent
100 km/h wind



Ignifugé M2
Fireproof M2



4 cm de neige
4 cm of snow

Grand Palais Vitré
Greenhouse «Grand Palais»



Grand Palais Vitré

Greenhouse «Grand Palais»

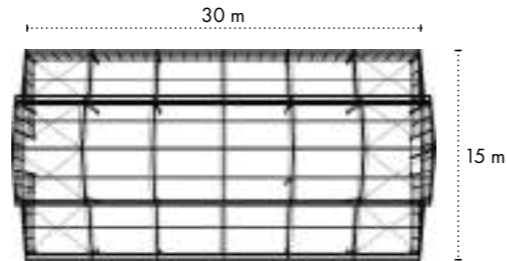
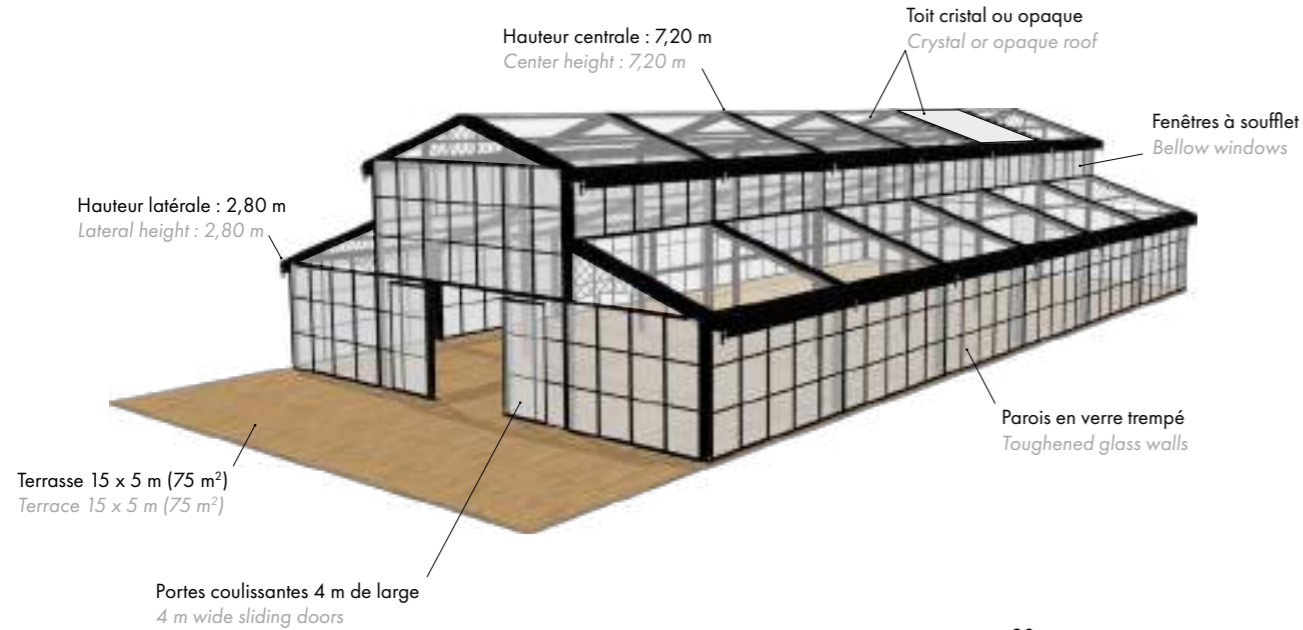

Capacité
Capacity

1,2 à 1,5 m²/p
1,2 to 1,5 m²/p



Accès PL obligatoire
HGV access required

- Structure entièrement modulable et extensible
- Entièrement vitrée (trempé 6 mm)
- Vue à 360° - luminosité exceptionnelle
- Ossature en aluminium noir
- Lustres et ventilation en option
- Toutes saisons

- Fully adjustable and extendable structure
- Fully glazed (6 mm toughened glass)
- 360° view - exceptional brightness
- Black aluminium structure
- Optional chandeliers and ventilation
- All-weather

ARRIMAGE STOWAGE



Ancrage piquet 85 - 115 cm
85 - 115 cm stake anchoring



Lestage béton par portique
Concrete ballast per gantry
1,5 - 2 t

Le montage du grand palais vitré nécessite un **ancrage par piquets**, toutefois, si le sol ne le permet pas, des lestés seront nécessaires.

Conventional set ups of greenhouse "grand palais" require **stakes to be used as anchors**, but if the ground does not allow this, ballast weights will be required.

MODÈLE DE LARGEUR 15 M 15 M WIDE MODEL



450 m²
30 x 15 x 7,20 m

MODÈLE DE LARGEUR 11 M 11 M WIDE MODEL

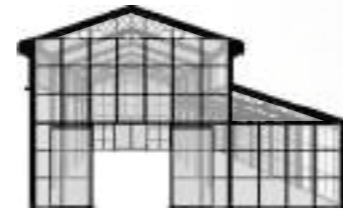

330 m²
30 x 11 x 7,20 m

MODÈLE DE LARGEUR 7 & 8 M 7 & 8 M WIDE MODEL



210 m²
30 x 7 x 7,20 m



240 m²
30 x 8 x 4,40 m

LONGUEUR MODULABLE ADJUSTABLE LENGTH



Modules de 5 m de long amovibles
Removable 5 m long modules

Collection
STRUCTURES ILLUMINÉES
ILLUMINATED STRUCTURES COLLECTION

« Brillez par votre originalité »
« Shine brightly »

LÉGENDE
KEY



60 km/h de vent
60 km/h wind



LED
LED



Faible consommation
Low consumption



IP65 étanche
IP65 waterproof



Structures illuminées

Illuminated structures

CUBE INDIEN
INDIAN CUBE

CÔNE INDIEN
INDIAN CONE

Hauteur : 4,5 à 5,70 m
Height : 4,5 to 5,70 m

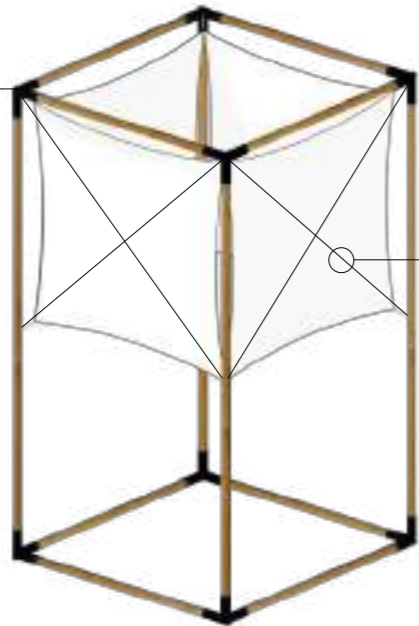

Couleur
Color

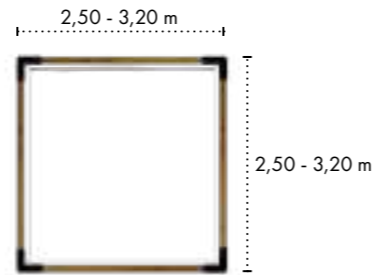

Capacité Capacity		1 à 10 1 to 10	

- Une création Be Lounge
- Structure bambou
- Toile micro-perforée
- Guirlandes blanc chaud
- A Be Lounge creation
- Bamboo structure
- Micro-perforated fabric
- Warm white garlands

GRAND MODÈLE
LARGE MODEL

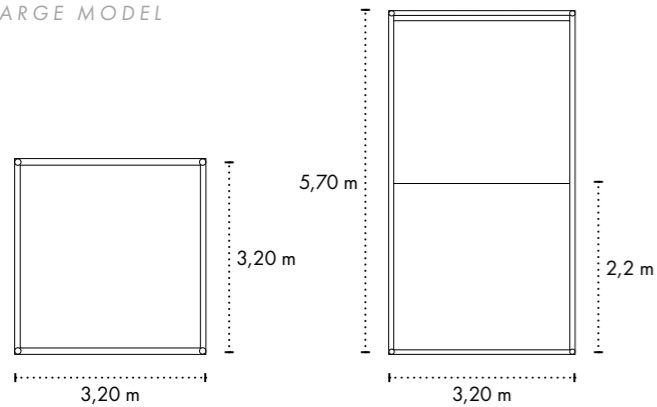

PETIT MODÈLE
SMALL MODEL

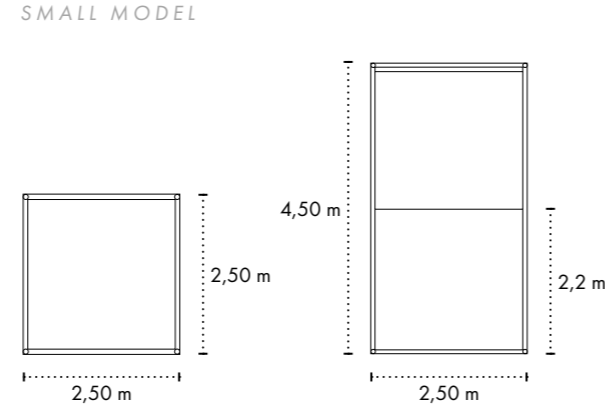

Hauteur : 4,5 m
Height : 4,5 m



Couleur
Color

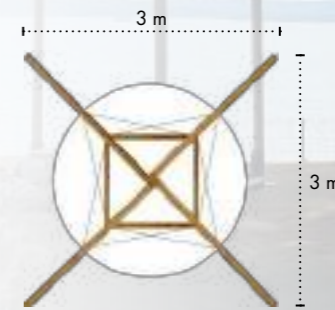

Capacité Capacity		1 à 10 1 to 10	

- Structure bambou
- Guirlande blanc chaud
- Toile haute densité
- Bamboo structure
- Warm white garland
- High density canvas

MODÈLE STANDARD
STANDARD MODEL

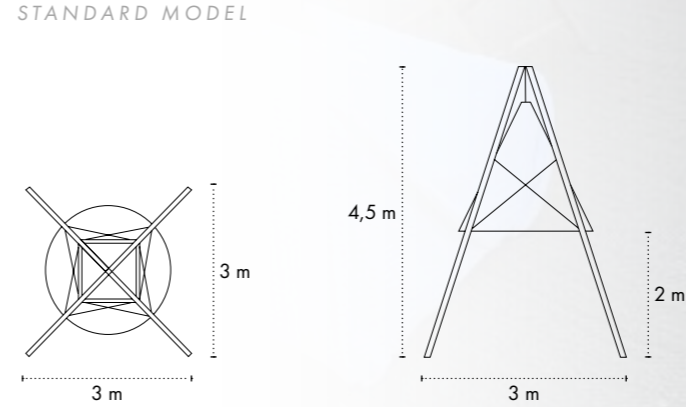

Structures illuminées
Illuminated structures



Collection
AMÉNAGEMENTS EXTÉRIEURS
EXTERIOR FITTINGS COLLECTION

« Transformez votre environnement »
« Change your environment »

LÉGENDE
KEY



Anti UV
UV protection



Étanche
Waterproof



100 km/h de vent
100 km/h wind



Ignifugé DIN 4102
Fireproof DIN 4102

Aménagements extérieurs

Exterior fittings



Voile d'ombrage scourtin

Scourtin shade sail

Support : **Bambou naturel** Support : *Natural bamboo*

Ancrage : **Piquets** Anchoring : *Stakes*

Matière : **Scourtin** Material : *Scourtin*

Couleur : *Color :*



Taille disponible : *Available size :*

4 x 4 x 3 m (16 m²)



Voile d'ombrage lycra

Lycra shade sail

Support : **Bambou naturel** Support : *Natural bamboo*

Ancrage : **Piquets** Anchoring : *Stakes*

Matière : **Lycra** Material : *Lycra*

Couleur : *Color :*



Taille disponible : *Available size :*

4 x 4 x 3 m (16 m²)



Aménagements extérieurs

Exterior fittings



Pergola / Houppa

Pergola / Houppa

Support : **Bambou naturel** *Support : Natural bamboo*

Ancrage : **Piquets** *Anchoring : Stakes*

Matière : **Voilage** *Material : Veiling*

Tailles disponibles : *Available sizes :*

3 x 3 x 3 m (**9m²**)

4 x 4 x 2,5 m (**16 m²**)

Existe aussi en chevron bois foncé.

Also available in dark wood herringbone.



Pagode / Office traiteur

Pagoda / Catering office

Hauteur latérale : **2,25 m** *Lateral height : 2,25 m*

Hauteur centrale : **3,5 m** *Central height : 3,5 m*

Matière : **Polyester 520 g** *Material : Polyester 520 g*

Option : **Plancher** *Option : Wooden floor*

Couleur : *Color:*



Tailles disponibles : *Available sizes :*

2 x 4 x 3,5 m (**8 m²**)

4 x 4 x 3,5 m (**16 m²**)





Mobilier

FURNITURE

Confort & raffinement
Comfort and sophistication

Collection
CHAISES
CHAIRS COLLECTION

« Pour être irremplaçable, il faut être différent »
« To be irreplaceable, you have to be different »

LÉGENDE
KEY



Empilable
Stackable



Pliable
Foldable



Nouveau
New



Naturel
Natural



Verni
Varnish



Huilé
Oiled

Chaises

Chairs



Chaise Enora noire

Black Enora chair

Bois naturel, peinture noire finition satin, assise et dossier en rotin naturel.

Natural wood, black satin paint finish, natural rattan seat and back.

41 x 44 x 86 cm

Hauteur assise : **46,5 cm** *Seat height : 46,5 cm*

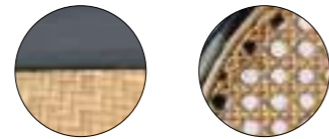

Chaise Enora blanche

White Enora chair

Bois naturel, peinture blanche finition satin, assise et dossier en rotin naturel.

Natural wood, white satin paint finish, natural rattan seat and back.

41 x 44 x 86 cm

Hauteur assise : **46,5 cm** *Seat height : 46,5 cm*

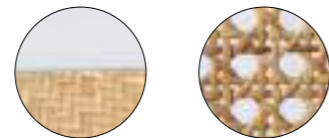

Chaises

Chairs



Chaise Pauline

Pauline chair

Bois naturel, finition patine huilée.
Galette type lin sable comprise.
Natural wood, oiled patina finish.
Sand flax type seat cushion included.

39,5 x 41,5 x 90 cm

Hauteur assise : **47 cm** *Seat height : 47 cm*



Chaise Adèle

Adèle chair

Bois naturel, finition patine huilée.
Galette type lin népal comprise.
Natural wood, oiled patina finish.
Nepal flax type seat cushion included.

39 x 39,5 x 97 cm

Hauteur assise : **47 cm** *Seat height : 47 cm*



Chaises

Chairs



Chaise Médaille Louise

Louise Medallion chair

Bois naturel, finition vernis couleur chêne, dossier blanc écru.

Galette blanc écru comprise.

Natural wood, oak varnish finish, unbleached white back. Off white seat cushion included.

45 x 49 x 96 cm

Hauteur assise : **50 cm** *Seat height : 50 cm*

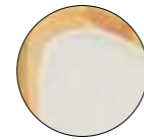

Chaise Médaille dos canné

Medallion cane back chair

Bois naturel, finition vernis vieilli, dossier en rotin naturel.

Galette blanc écru comprise.

Natural wood, aged varnish finish, natural rattan back. Off white seat cushion included.

45,5 x 48 x 98 cm

Hauteur assise : **51 cm** *Seat height : 51 cm*

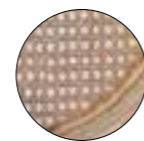

Chaises

Chairs



Chaise Mahaut

Mahaut chair

Bois naturel, finition vernis couleur chêne, siège et dossier en rotin synthétique.

Natural wood, oak varnish finish, synthetic rattan seat and back.

40,5 x 40,5 x 77,5 cm

Hauteur assise : **45 cm** *Seat height : 45 cm*

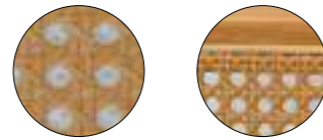

Chaise Napoléon

Napoleon chair

Bois naturel, finition patine huilée.

Galette type lin népal comprise.

Natural wood, oiled patina finish.

Nepal flax type seat cushion included.

41 x 38,5 x 91 cm

Hauteur assise : **46 cm** *Seat height : 46 cm*



Chaises

Chairs



Chaise Fermob

Fermob chair

Acier, peinture blanche. Lattes en bois vernis couleur chêne.

Galette blanche en option.

Steel, white paint. oak-coloured varnished wooden slats.
Optional white seat cushion.

29 x 38 x 80 cm

Hauteur assise : 47 cm Seat height : 47 cm

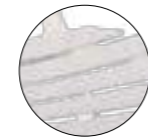

Chaise Anna

Anna chair

Bois de hêtre, finition vernis, design nordique.

Galette molletonnée écru en option.

Beech wood, varnished finish, nordic design.
Optional cream fleece seat cushion.

53,5 x 55 x 80 cm

Hauteur assise : 45 cm Seat height : 45 cm



Chaises

Chairs



Chaise Camille

Camille chair

Bois naturel, blanc patiné.

Galette blanche comprise.

Natural wood, aged white finish.

White seat cushion included.

40 x 40 x 92 cm

Hauteur assise : 45 cm Seat height : 45 cm

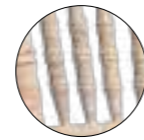

Chaise Julia

Julia chair

Bois naturel, finition vernis couleur chêne.

Assise rembourrée en rotin naturel.

Natural wood, oak varnish finish.

Padded seat in natural rattan.

41 x 41 x 91 cm

Hauteur assise : 45,5 cm Seat height : 45,5 cm



Collection
TABOURETS & BANCS
STOOLS & BENCHES COLLECTION

« L'élégance est dans les détails qui ne se voient pas »
« Elegance is in the details that don't show »

LÉGENDE
KEY



Empilable
Stackable



Pliable
Foldable



Nouveau
New



Naturel
Natural

Tabourets & bancs

Stools & benches



Tabouret Victoria

Victoria stool

Acier, finition peinture noire,
patine légèrement dorée.
*Steel, black paint finish,
light golden patina.*

31 x 31 x 77 cm

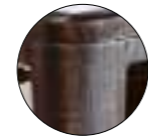

Tabouret Paris bistrot

Paris bistrot stool

Structure en rotin naturel, assise tressée,
finition couleur blanc et cappucino.
*Natural rattan structure, woven seat,
white and cappuccino finish.*

ø 35 cm

Hauteur : 76 cm *Height : 76 cm*



Tabourets & bancs

Stools & benches



Tabouret Laurane

Laurane stool

Assise et dossier en bois naturel, structure métal.
Natural wood seat and back, metal structure.

33 x 46 x 101 cm

Hauteur assise : **78 cm** Seat height : 78 cm



Banc Léon

Léon bench

Assise et structure en bois rustique.
Seat and structure in rustic wood.

200 x 36 x 45 cm



Collection
TABLES À MANGER
DINING TABLES COLLECTION

« *La simplicité est l'ultime sophistication* »
« *Simplicity is the ultimate sophistication* »

LÉGENDE
KEY



Pliable
Foldable



Naturel
Natural



Bois noble
Noble wood



Verni
Varnish

Tables à manger

Dining tables



Table rectangulaire Ethnicraft en chêne

Rectangular Ethnicraft wooden table

Bois de chêne massif naturel, finition vernis. **Ne nécessite aucun nappage.**
Natural solid oak, varnished finish. No tablecloth required.

240 x 100 x 75 cm



8 à 10 personnes
8 to 10 people



Ethnicraft

Le charme du bois massif

The charm of solid wood

Ethnicraft est le spécialiste du mobilier en bois brut. Fabriquées en bois de chêne, vernies, nos tables mettront en valeur votre décoration. D'une qualité et d'une finition irréprochables, elles s'accordent avec toute notre gamme de chaises.

Ethnicraft is the specialist in raw wood furniture. Made from oak and varnished, our tables will enhance your decor. With their impeccable quality and finish, they match our entire range of chairs.

Tables à manger
Dining tables



Un design authentique

Authentic design

Depuis vingt-cinq ans, Ethnicraft crée des meubles contemporains et intemporels à partir de bois massif et de matériaux naturels. Notre collection donne la priorité à ce que nous pensons être l'essence d'un design de qualité : des pièces de caractère, fabriquées à partir de matériaux nobles qui s'embelliront avec le temps.

For twenty-five years, Ethnicraft has been creating contemporary, timeless furniture from solid wood and natural materials. Our collection focuses on what we believe to be the essence of quality design : pieces with character, made from noble materials that will embellish over time.

Ethnicraft



Table ronde Ethnicraft en chêne

Round Ethnicraft wooden table

Bois de chêne massif naturel, finition vernis. **Ne nécessite aucun nappage.**
Natural solid oak, varnished finish. No tablecloth required.

ø 160 cm

Hauteur : 75 cm *Seat height : 75 cm*



6 à 8 personnes
6 to 8 people

Tables à manger
Dining tables



Tables à manger

Dining tables



Table Wagon chêne bi-centenaire

Oak bi-centennial wagon table

Bois de chêne vieilli de 200 ans, finition vernis. **Ne nécessite aucun nappage.**
200 year old oak, varnished finish. *No tablecloth required.*

200 x 80 x 75 cm



6 à 8 personnes
6 to 8 people



Tables à manger
Dining tables



Tables à napper

Polypropylene tables



Table rectangulaire

Rectangular table

Plateau en polypropylène, ossature acier.

Disponible avec un plateau en bois.

Polypropylene tray, steel structure.

Available with a wooden top.

 **x6** 182 x 76 x 75 cm

 **x8** 200 x 90 x 74 cm
200 x 100 x 74 cm



Table d'honneur

Honor table

Plateau en polypropylène, ossature acier.

Polypropylene tray, steel structure.

Longueur : **Sur-mesure** Length : Custom-made

Largeur : **148 cm** Width : 148 cm

Hauteur : **75 cm** Height : 75 cm

 **x6 - 28**

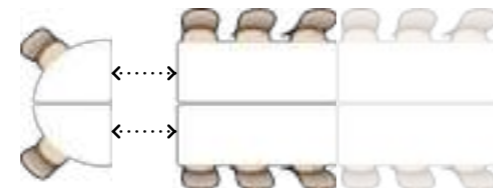

Table ronde

Round table

Plateau en polypropylène, ossature acier.

Polypropylene tray, steel structure.

 **x8** ø 150 cm
Hauteur : **75 cm** Height : 75 cm

 **x10** ø 180 cm
Hauteur : **75 cm** Height : 75 cm

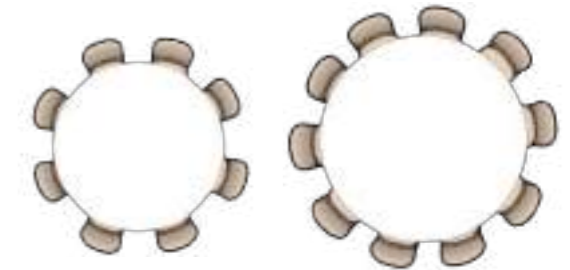

Table buffet

Buffet table

Plateau en polypropylène, ossature acier.

Hauteur réglable.

Polypropylene tray, steel structure.

Adjustable height.

182 x 75 x 75/90 cm



Collection
COINS SALON
LOUNGE SETS COLLECTION

« *La mode passe, le style reste* »
« *Fashion goes, style stays* »

LÉGENDE
KEY



Nouveau
New



Naturel
Natural



Usage extérieur
Outdoor use

Coins salon

Lounge sets

Salon BAMBOU

Notre mobilier Bambou est livré avec ses coussins d'assise gris clair.
Our Bamboo furniture comes with light grey seat cushions.

Bambou naturel.
Natural bamboo.



LE SALON COMPLET FULL SET



x4



x1 (3 places)
(3 seats)



x1



x8 Coussins « Prestige » inclus
x8 « Prestige » cushions included



Le canapé

The sofa

185 x 72,5 x 70 cm

Hauteur assise : 36 cm
Seat height : 36 cm



Le fauteuil

The armchair

60 x 72,5 x 70 cm

Hauteur assise : 36 cm
Seat height : 36 cm



La table basse

The coffee table

70 x 70 x 45 cm

Coins salon
Lounge sets



Coins salon

Lounge sets

Salon FLORENCE

Notre mobilier Florence est livré avec ses coussins d'assise et dossiers beiges capitonnés.
Our Florence furniture comes with upholstered chino seat and back cushions.

Structure en rotin naturel.
Natural rattan fibre structure.



LE SALON COMPLET FULL SET



x2



x1 (2 places)
(2 seats)



x1



Le canapé

The sofa

92,5 x 52,5 x 72 cm

Hauteur assise : **37,5 cm**
Seat height : 37,5 cm



Le fauteuil

The armchair

50 x 52,5 x 72 cm

Hauteur assise : **37,5 cm**
Seat height : 37,5 cm



La table basse

The coffee table

ø 59,5 cm

Hauteur : **50 cm**
Height : 50 cm

Coins salon
Lounge sets



Coins salon

Lounge sets

Salon IPANEMA

Notre mobilier Ipanema est livré avec ses coussins d'assise et dossiers blanc crème.

Our Ipanema furniture comes with creamy white seat and back cushions.

Structure en aluminium blanc mat, cordages tressés.

Structure in matt white aluminium, braided ropes.



LE SALON COMPLET FULL SET



x2



x1 (2 places)
(2 seats)



x2



Le canapé

The sofa

142 x 57 x 66 cm

Hauteur assise : **36 cm**

Seat height : 36 cm



Le fauteuil

The armchair

64 x 57 x 66 cm

Hauteur assise : **36 cm**

Seat height : 36 cm



La table basse

The coffee table

65 x 48 x 30 cm

Coins salon
Lounge sets



Coins salon

Lounge sets

Salon LOUNGE

Cette collection est le premier né. Elle a meublé plusieurs scénographies de renommée internationale telles que les soirées du gala de l'amfAR durant 6 ans pendant le Festival de Cannes.

Our Lounge furniture is the very first addition to the Be Lounge collection. It furnished a number of internationally-renowned sets, including the amfAR gala evenings for 6 years during the Cannes Festival.

Mousse flexible imperméable blanc mat.
Waterproof flexible foam in matt white.



LE SALON COMPLET FULL SET



x1 (4 places)
(4 seats)



x2



x1 (4 places)
(4 seats)



x1



Le canapé

The sofa

160 x 93 x 65 cm

Hauteur assise : 34 cm

Seat height : 34 cm



Le banc

The bench

160 x 40 x 35 cm



Le pouf

The pouf

40 x 40 x 35 cm



La table basse

The coffee table

Plateau polycarbonate blanc
White polycarbonate tray

60 x 60 x 35 cm

74 x 74 x 35 cm

Coins salon
Lounge sets



Coins salon

Lounge sets

Salon CHESTERFIELD

Notre collection Chesterfield est à privilégier pour un usage intérieur.
Our Chesterfield collection is ideal for indoor use.

Mobilier en cuir véritable, vieilli et capitonné.
Genuine leather furniture, distressed and upholstered.



LE SALON COMPLET FULL SET



x2



x1 (3 places)
(3 seats)



x2



x1



Le canapé

The sofa

200 x 90 x 75 cm

Hauteur assise : 50 cm

Seat height : 50 cm



Le fauteuil

The armchair

115 x 90 x 75 cm

Hauteur assise : 50 cm

Seat height : 50 cm



Le pouf

The pouf

40 x 40 x 45 cm



La table basse

The coffee table

100 x 80 x 47,5 cm

Coins salon
Lounge sets



Collection
MOBILIER D'APPOINT
OCCASIONAL FURNITURE COLLECTION

« Terminez en beauté »
« Finish in style »

LÉGENDE
KEY



Empilable
Stackable



Pliable
Foldable



Nouveau
New



Naturel
Natural

Mobilier d'appoint

Occasional furniture



Mange-debout Blanc de Blanc

White of white high table

Structure en métal finition peinture blanche,
plateau stratifié.

Metal structure with white paint finish, laminate top.

Ø 59 cm

Hauteur : 105 cm *Height : 105 cm*



Mange-debout Victor

Victor high table

Structure en aluminium brossé noir,
plateau en bois rustique.

Black brushed aluminium structure, rustic wood top.

Ø 70 cm

Hauteur : 110 cm *Height : 110 cm*

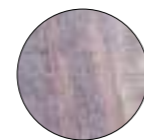

Mobilier d'appoint

Occasional furniture



Mange-debout Saint Germain

Saint Germain high table

Structure en métal & aluminium stratifié, plateau effet marbre, bord doré.

Laminated metal & aluminium structure, marble-effect top, gilded edge.

ø 60 cm

Hauteur : 115 cm *Height : 115 cm*

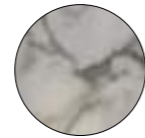

Mange-debout Teck

Teak high table

Structure et plateau en teck verni.

Varnished teak structure and top.

70 x 70 x 103 cm



Mobilier d'appoint

Occasional furniture



Table basse Léon

Léon coffee table

Structure en bois rustique.
Rustic wood structure.

100 x 80 x 47,5 cm

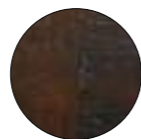

Table haute Léon

Léon high table

Structure en bois rustique.
Rustic wood structure.

225 x 70 x 110 cm



Mobilier d'appoint

Occasional furniture



Guéridon Cooper doré

Golden Cooper pedestal table

Structure en métal & plateau texturé.
Metal structure & textured top.

ø 70 cm

Hauteur : 75 cm Height : 75 cm



Guéridon Cooper blanc

White Cooper pedestal table

Structure en métal & plateau texturé.
Metal structure & textured top.

ø 70 cm

Hauteur : 75 cm Height : 75 cm



Mobilier d'appoint

Occasional furniture



Chaise Paris bistrot

Paris Bistro chair

Structure en rotin naturel, assise tressée, finition couleur blanc et cappuccino.

Natural rattan structure, woven seat, white and cappuccino finish.

53 x 48 x 96 cm

Hauteur assise : **45 cm** Seat height : 45 cm



Table bistrot Saint Germain

Saint Germain bistro table

Structure en métal & aluminium stratifié, plateau effet marbre, bord doré.

Laminated metal & aluminium structure, marble-effect top, gilded edge

70 x 70 x 76 cm

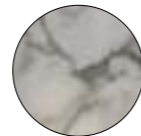

Mobilier d'appoint

Occasional furniture



Fauteuil Giverny

Giverny armchair

Structure en bois, finition en rotin tressé.

Disponible en brun et blanc.

Wooden structure, woven rattan finish.

Available in brown and white.

41,5 x 56 x 81 cm

Hauteur assise : 45 cm *Seat height : 45 cm*



Chaise longue Chilienne

Chilienne long chair

Structure en bambou naturel, assise et dossier en tissu blanc crème.

Hauteur réglable.

Natural bamboo structure, seat and back in creamy white fabric.

Adjustable height

112 x 60 x 80 cm

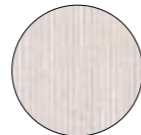

Collection
BARS & COMPTOIRS
BARS & COUNTERS COLLECTION

« *Un cocktail de pièces d'exception* »
« *A cocktail of exceptional pieces* »

LÉGENDE
KEY



Pliable
Foldable



Nouveau
New



Naturel
Natural

Bars & comptoirs

Bars & counters



Bar Rustique

Rustique bar

Structure en bois rustique, plateau en zinc.
Rustic wood structure, zinc top.

GRAND MODÈLE LARGE MODEL

180 x 50 x 107 cm



PETIT MODÈLE SMALL MODEL

120 x 50 x 107 cm



Bars & comptoirs

Bars & counters



Bar Guinguette bois naturel

Guinguette light wood bar

Structure en bois couleur brun clair,
plateau en bois, parois pliables.

Light slate brown wooden structure, wooden top, folding sides.

210 x 80 x 110 cm



Bar Guinguette bois blanc

Guinguette white wood bar

Structure en bois couleur blanc patiné,
plateau en bois, parois pliables.

White weathered wooden structure, wooden top, folding sides.

210 x 80 x 110 cm



Bars & comptoirs

Bars & counters



Bar Rotonde

Rotonde bar

Structure et plateau en bois, composée de 3 modules.
Wooden structure and top, made up of 3 independent modules.

Extérieur **ø 3,5 m** *Exterior ø 3,5 m*

Hauteur : **110 cm** *Height: 110 cm*



Bars & comptoirs

Bars & counters



Bar Joséphine

Joséphine bar

Structure en bois couleur noir ardoise, plateau en cuivre « Rosegold ».

Slate black structure, « Rosegold » copper tray.

180 x 50 x 110 cm



Étagère fond de bar vintage

Vintage bar shelf

Structure en fer, caissons en bois de manguier.

Iron structure, mango wood boxes.

86 x 40 x 187 cm



Bars & comptoirs

Bars & counters



Bar Jeanne

Jeanne bar

Structure en bois couleur blanc, plateau en bois.

Façade en cannage, vitrée.

White wooden structure, wooden top. Cane front, glazed.

180 x 65 x 100 cm

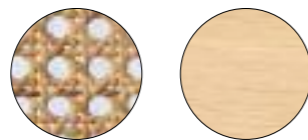



Éclairage

LIGHTING

Brillez de mille feux
Shine brightly

Collection
GUIRLANDES
GARLANDS COLLECTION

« Des étoiles plein les yeux »
« Stars in the eyes »

LÉGENDE
KEY



LED
LED



Dimmable
Dimmable



Consommation*
Consumption*



IP65 étanche
IP65 waterproof



Raccordable
Connectable

Guirlande Guinguette

Bistro garland

Modèle ampoules blanc chaud cordon blanc **12 ou 25 m**
Transparent bulbs with warm white light white cord model 12 or 25 m

Modèle ampoules blanc chaud cordon noir **12 ou 25 m**
Transparent bulbs with warm white light black cord model 12 or 25 m



100 W / 25 m



Guirlande Loupiote

Spark garland

Modèle ampoules blanc chaud cordon blanc **20 m**
Warm white bulbs with a white cord 20 m

Modèle ampoules blanc chaud cordon noir **20 m**
Warm white bulbs with a black cord 20 m

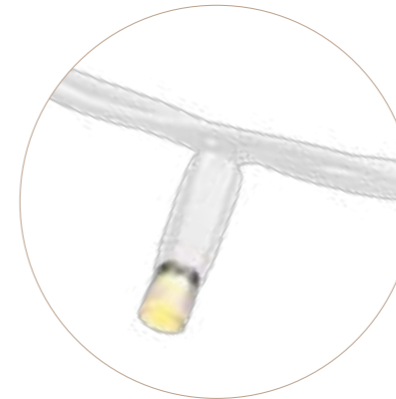

15 W / 20 m



Nos guirlandes Guinguette sont d'une longueur de 12 ou 25 m. Leurs ampoules LED blanc chaud offriront une lumière qui s'adaptera au mieux à votre espace grâce à leur variateur*. Vous pourrez modifier l'intensité et choisir de tamiser davantage une fois la fête lancée.

Our Bistro garlands are 12 or 25 m long. Their warm white LED bulbs offer a light that's perfectly suited to your space, thanks to their dimmer switch. You can change the intensity and choose to dim the light even further once the party has started.*

*Variateur en option
*Optional dimmer switch

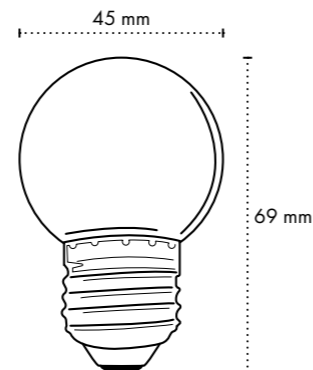

Nos guirlandes Loupiote, d'une longueur de 20 m, ont un cordon blanc ou noir avec des petites ampoules fines. Elles pourront s'utiliser pour créer des «ciels étoilés» ou encore pour entourer et illuminer les mâts et les arbres. L'éclairage est plus doux et tamisé que les guirlandes classiques.

Our Spark garlands are 20 m long and have a white or black cord with small, thin bulbs. They can be used to create "starry skies" or to surround and illuminate poles and trees. The lighting is softer and more subdued than traditional garlands.

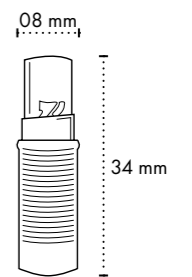

Guirlande Guinguette
Bistro garland



Guirlande Loupiote
Spark garland



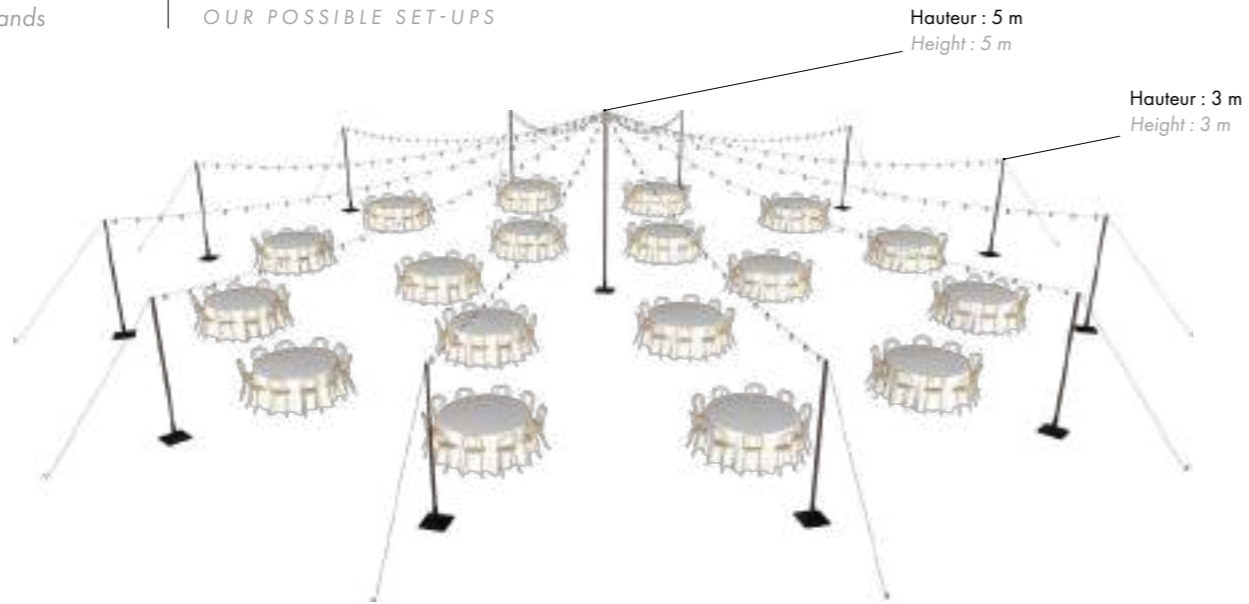

Montages possibles pour guirlandes **Guinguette / Loupiote**.
Our possible set-ups for **Bistro / Spark** garlands.



Carrousel de lumière Light carousel

Disponibles en 2 tailles :
Available in 2 sizes :

ø 12 m (113 m²)
ø 25 m (490 m²)

Ancrage : **Piquets ou lestage**
Anchoring : *Stakes or ballast*



Sur-mesure Custom-made

Disponible dans les dimensions de
votre choix.
Available in the dimensions of your choice.

Ancrage : **Piquets ou lestage**
Anchoring : *Stakes or ballast*

Guirlandes

Garlands

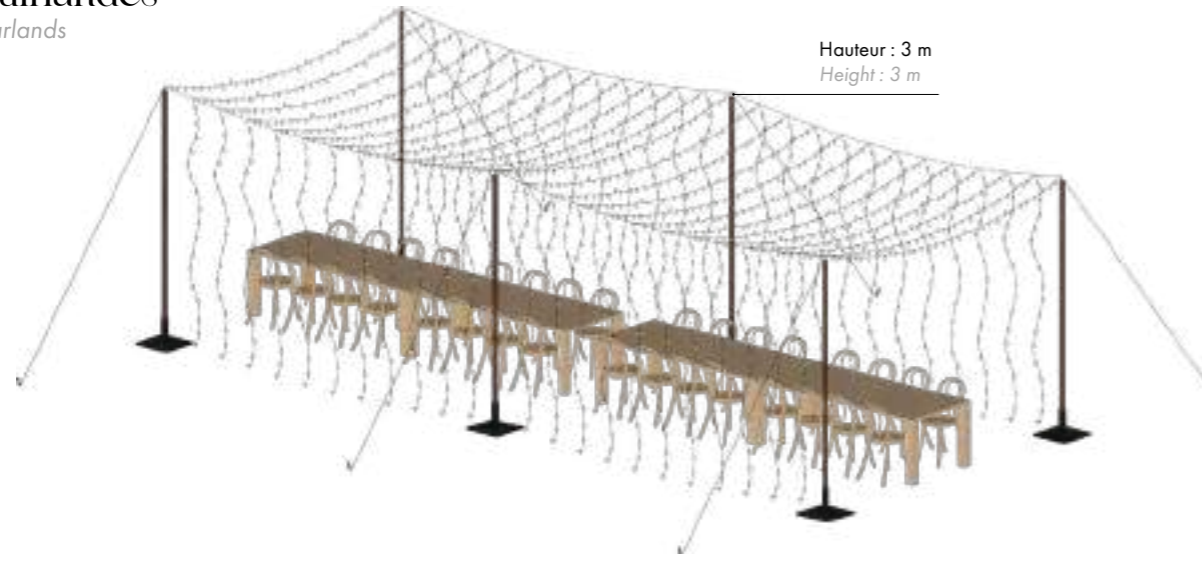

Hauteur : 3 m
Height : 3 m

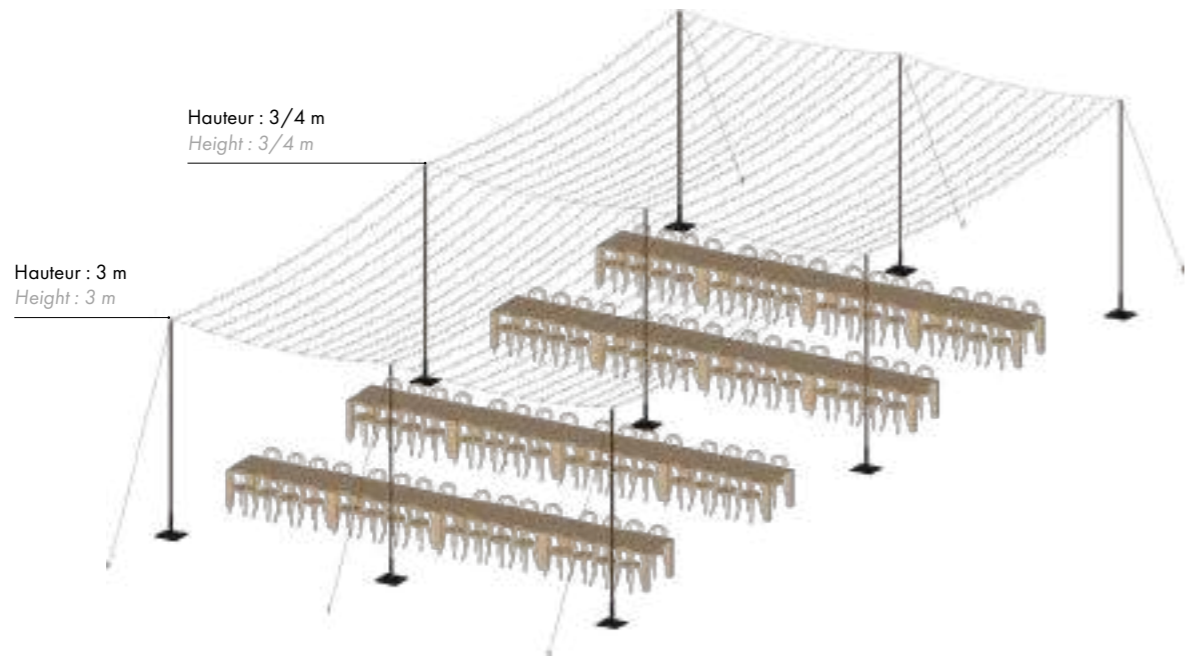

Hauteur : 3/4 m
Height : 3/4 m

Hauteur : 3 m
Height : 3 m

Montages possibles pour guirlandes **Loupiote**.
Our possible set-ups for **Spark garlands**.



Couloir de Loupiote

Light corridor

Disponible dans les dimensions de votre choix.
Available in the dimensions of your choice.

Ancrage : **Piquets ou lestage**

Anchoring : *Stakes or ballast*



Ciel étoilé

Starry sky

Disponible dans les dimensions de votre choix.
Available in the dimensions of your choice.

Ancrage : **Piquets ou lestage**

Anchoring : *Stakes or ballast*

Collection
SPOTS AUTONOMES
AUTONOMOUS SPOTLIGHTS COLLECTION

« *Et la lumière fut* »
« *And there was light* »

LÉGENDE
KEY



LED
LED



Faible consommation
Low consumption



IP65 étanche
IP65 waterproof



Batterie
Battery

Spots autonomes

Autonomous spotlights



Mirage / Color Event

Pack de 6 Pack of 6

Spot indirect LED RGB programmable (toutes couleurs).
Fonctionne sur batterie.

Autonomie de 12h.

Indirect LED RGB Spotlight programmable (all colors).
Battery operated. 12h autonomy.

Idéal pour un éclairage localisé.

Ideal for a targeted lighting.



SpotLite

Pack de 8 Pack of 8

Spot indirect LED RGB programmable (toutes couleurs)
via application mobile. Fonctionne sur batterie.

Autonomie de 10 à 14h.

Programmable indirect RGB LED spotlight (all colors) via
application. Battery operated, 10 to 14 hours autonomy.

Idéal pour un éclairage ciblé.

Ideal for targeted lighting.



SpotMax

Pack de 2 Pack of 2

Spot indirect LED RGB programmable (toutes couleurs)
via application mobile. Fonctionne sur batterie

Autonomie de 10 à 14h.

Programmable indirect RGB LED spotlight (all colors) via
application. Battery operated, 10 to 14 hours autonomy.

Idéal pour un éclairage puissant.

Ideal for powerful lighting.



Collection
ACCESSOIRES LUMINEUX
LIGHTING ACCESORIES COLLECTION

« N'éteignez pas encore la lumière... »
« Don't turn out the lights yet... »

LÉGENDE
KEY



LED
LED



Faible consommation
Low consumption



Batterie
Battery



Anti moustiques
Mosquito repellent

Accessoires lumineux

Lighting accessories



Torche nomade

Nomadic torch

Bougie à la citronnelle.

Citronella candle.

Ø 30 cm

Hauteur : 140 cm Height : 140 cm

Matière : Bois, métal et cire Material : Wood, metal and wax

Autonomie : 24 h Autonomy : 24 h



Sac lanterne

Lantern bag

Faciles à mettre en place grâce aux bougies LED anti-feu.

Easy to set up thanks to the fireproof LED tealights supplied.

12 x 12 x 20 cm

Matière : Papier Material : Paper

Autonomie : 200 h Autonomy : 200 h



Accessoires lumineux

Lighting accessories

LUSTRES BALINAIS BALINESE CHANDELIERS

Paire d'ampoules rechargeables autonomes en option.
L'éclairage de chaque lustre est contrôlable avec une télécommande.

Pair of self-contained rechargeable bulbs in option.
The lighting of each chandelier can be controlled by remote control.



Champignon
Mushroom

50 x 50 x 50 cm

Matière : **Rotin** *Material : Rattan*



Ellipse
Ellipse

30 x 30 x 48 cm

Matière : **Rotin** *Material : Rattan*



Montgolfière
Hot-air balloon

22 x 22 x 50 cm

Matière : **Rotin** *Material : Rattan*



Squid
Squid

30 x 30 x 110 cm

Matière : **Rotin** *Material : Rattan*



Nabuco
Nabuco

35 x 35 x 70 cm

Matière : **Rotin** *Material : Rattan*



Cône
Cone

22 x 22 x 62 cm

Matière : **Rotin** *Material : Rattan*



IV

Revêtements

FLOORING

Pour le plaisir des talons
For the pleasure of heels

Collection
PLANCHER
WOODEN FLOOR COLLECTION

« *Touchez du bois* »
« Knock on wood »

Plancher

Wooden floor

Nous garantissons une stabilité parfaite et régulière sur votre terrain avec notre plancher autoporté, muni d'une ossature en acier à double nappe. Nivelé par nos équipes à l'aide de chandelles, ce revêtement permet d'accroître vos espaces de réception et notre stock en sapin brut de plus de 3 000 m² devrait vous donner des idées de grandeur !

We guarantee perfect, even stability for your site with our self-supporting, double-layer steel framed flooring. Levelled by our teams using wedge candles, this flooring allows you to expand your reception areas, and our raw fir tree stock of over 3 000 m² should give you ideas of size !



CONFORT OPTIMAL OPTIMUM COMFORT

Dans un souci permanent du détail, le plancher sera entouré de coton gratté ou (film extandex) afin que la structure en acier soit dissimulée.
With an eye for detail, the wooden floor will be surrounded by scraped cotton or (extandex film) to conceal the steel structure.

TRANSPORT TRANSPORT

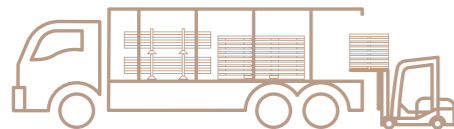

PL 19/26 t + Chariot élévateur 2,7 t
19/26 t HGV + 2.7 t forklift

Le transport du plancher et sa manipulation nécessitent une **logistique particulièrement importante**. Un repérage technique sera **indispensable** pour confirmer la faisabilité du projet.

Transporting and handling the wooden floor is a **particularly demanding logistical task**. A technical survey is **essential** to confirm the feasibility of the project.

ZOOM SUR LE PLANCHER ZOOM ON THE WOODEN FLOOR

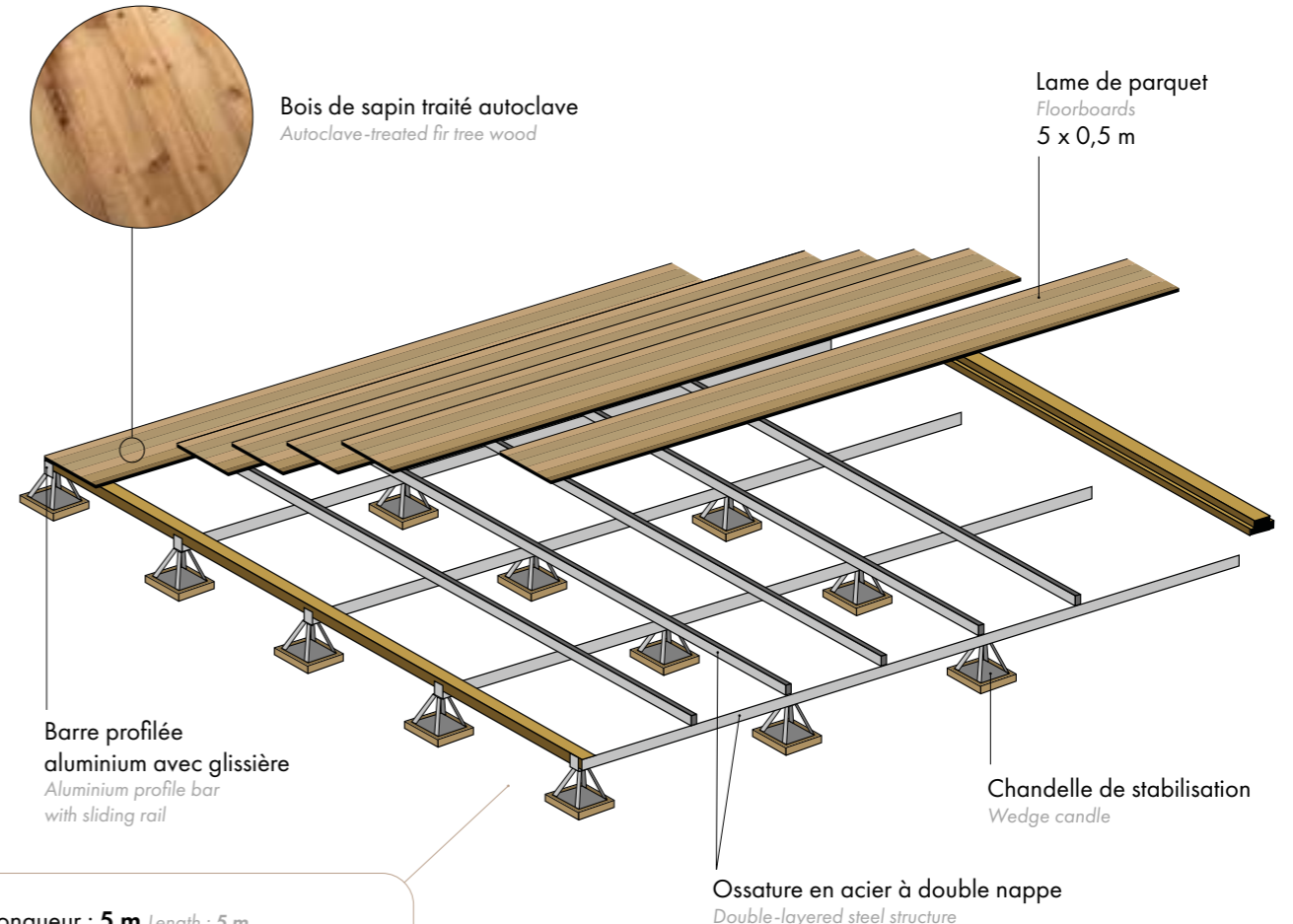

Longueur : 5 m Length : 5 m
Largeur : 5 m Width : 5 m
Hauteur : 20 à 80 cm Height : 20 to 80 cm

ANCRAGE ANCHORING



Piquet 85 cm
85 cm stake



Chandelle 20 à 80 cm
Wedge candle 20 to 80 cm

Fixation au sol et mise à niveau à l'aide de **chandelles de stabilisation et de piquets**.

Secured to the ground and levelled with **wedge candles and stakes**.



COLONNES DE STABILISATION STABILISATION COLUMNS

Les colonnes de stabilisation peuvent prendre en charge des sols inclinés et irréguliers jusqu'à 12 degrés au moyen d'une fonctionnalité « d'ajustement d'angle » intégrée à l'ensemble des plaques de base/colonnes primaires.

Stabilisation columns can handle sloping and uneven floors of up to 12 degrees by means of an « angle adjustment » feature built into the baseplate/primary column assembly.

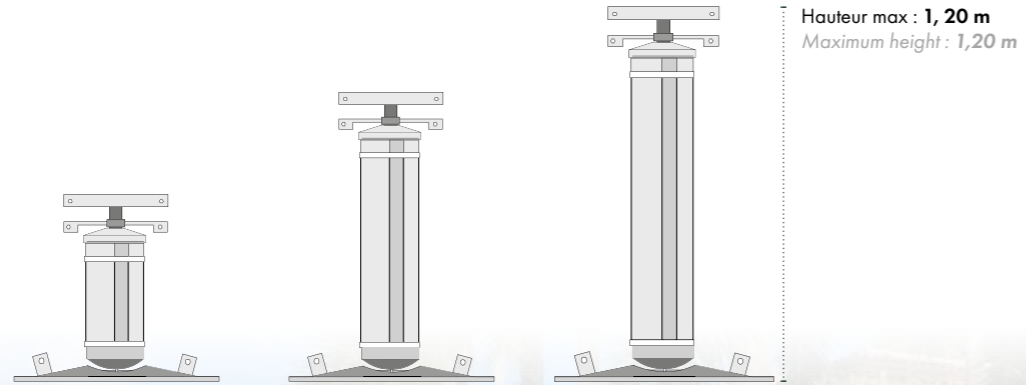

Collection

PISTE DE DANSE
DANCEFLOOR COLLECTION

« *Jusqu'au bout de la nuit* »
« *To the end of the night* »

Piste de danse

Dancefloor

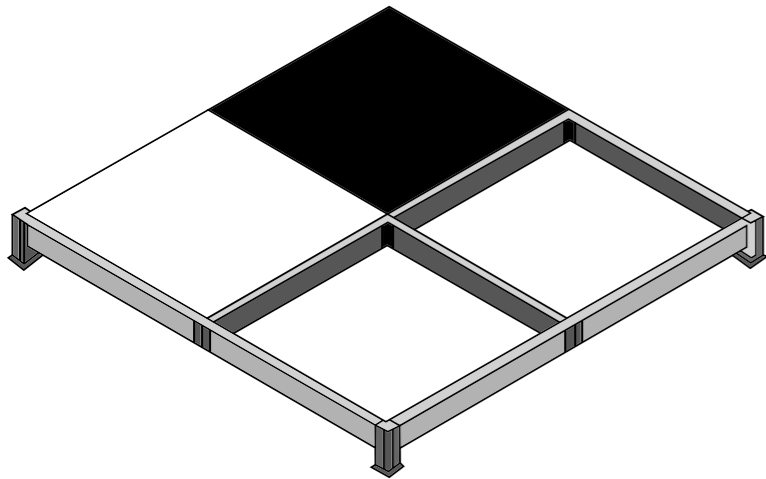
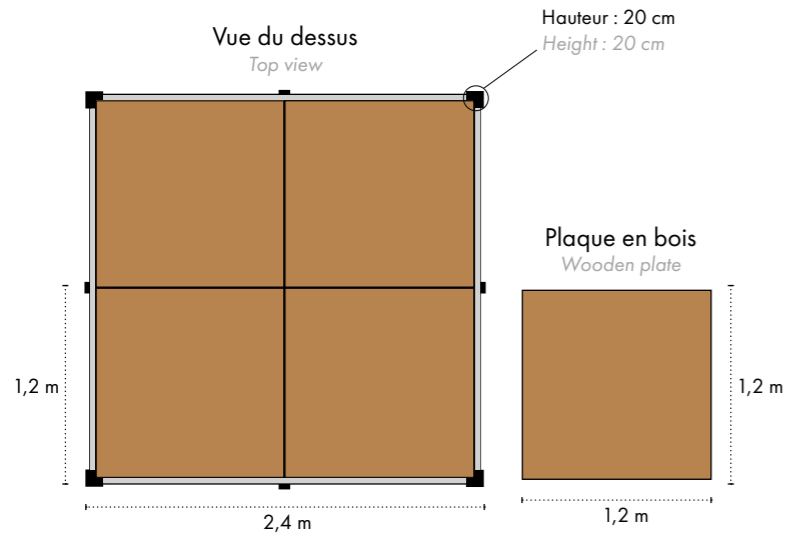

Bois couleur cognac

Color cognac wood

Plaques de bois, finition huile teintée, posées sur une armature métallique.

Wooden plates, tinted oil finish, laid on a metal frame.

1,2 x 1,2 x 0,20 m



Damier noir & blanc

Black & white checkerboard

Plaques de bois noires/blanches, finition laquée, posées sur une armature métallique.

Black/ white wooden plates, lacquer-finish, laid on a metal frame.

1,2 x 1,2 x 0,20 m



CONFORT OPTIMAL OPTIMUM COMFORT

Dans un souci permanent du détail, la piste sera entourée de coton gratté ou (film extandex) afin que la structure en acier soit dissimulée.

With an eye for detail, the dancefloor will be surrounded by scraped cotton or (extandex film) to conceal the steel structure.

Collection

MOQUETTE & SOL NATUREL
CARPET & NATURAL FLOOR COLLECTION

« *Vous savez où vous mettez les pieds* »
« *You know what you're getting into* »

Moquette & Sol naturel

Carpet & Natural floor



Moquette éco-responsable

Eco-responsible carpet

Moquette 100% recyclable.
Habille toutes les surfaces.
100% recyclable carpet. Suitable for all surfaces.

Uniquement en complément de location.
Only in addition to rental.

Longueur : **Sur-mesure** *Length : Custom-made*

Largeur : **2 m** *Width : 2 m*

Matière : **Fibre textile** *Material : Textile fibre*

Poids : **0,71 kg / m²** *Weight : 0,71 kg / m²*



Sol naturel

Natural floor

Tapis coco, jonc de mer... Nous sommes en mesure de couvrir toutes surfaces.

Consultez-nous.

Coconut matting, sea rush... We can cover any surface. Just ask.

Uniquement en complément de location.
Only in addition to rental.

Longueur : **Sur-mesure** *Length : Custom-made*

Largeur : **4 m** *Width : 4 m*

Matière : **Fibre naturelle** *Material : Natural fibre*

Poids : **3 kg / m²** *Weight : 3 kg / m²*



Collection
ESTRADE
STAGE COLLECTION

« Prenez la parole »
« Make a speech »

Estrade

Stage

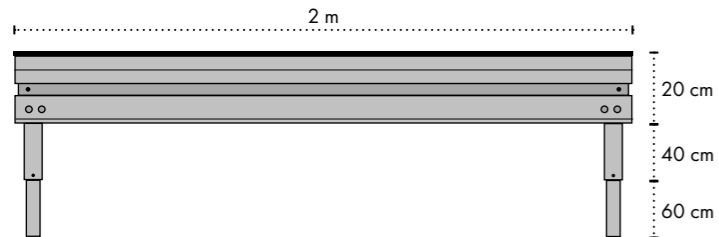
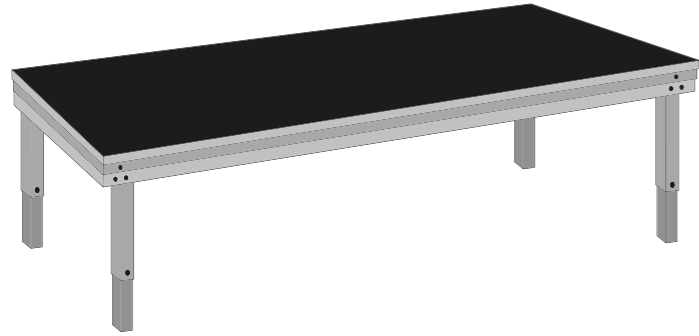

Estrade

Stage

Pour une animation ou un discours réussi, notre estrade sera parfaite pour créer une scène ou un podium.

For a successful event or speech, our stage will be perfect for creating a stage or podium.

Module :

2 x 1 m x 0,20/0,40/0,60 m

CONFORT OPTIMAL OPTIMUM COMFORT

Dans un souci permanent du détail, l'estrade sera entourée de coton gratté ou (film extandex) afin que la structure en acier soit dissimulée.

With an eye for detail, the scene will be surrounded by scraped cotton or (extandex film) to conceal the steel structure.





V

Les petits +
LITTLE EXTRAS

L'importance du détail
Attention to detail

Collection
PARASOLS
PARASOLS COLLECTION

« *Ils vous feront de l'ombre* »
« *They'll overshadow you* »

Parasols

Parasols



Parasol Luxe

Luxury parasol

Platine autolestée, structure en eucalyptus, autolift.
Self-bolting turntable, eucalyptus structure, autolift.

3 x 3 x 2,57 m

Couleurs : Colors :



Parasol Cyclades

Cyclades parasol

Platine autolestée, structure en teck, cordes tressées blanc crème.
Self-bolting turntable, teak structure, creamy white braided ropes.

ø 2,5 m

Hauteur : **2,29 m** Height : 2,29 m



Collection

SOLUTIONS CHAUFFANTES
HEATED SOLUTIONS COLLECTION

« Une ambiance chaleureuse »
« A warm atmosphere »

Solutions chauffantes

Heated solutions



Brasero Marbella

Marbella brazier

Notre brasero bénéficie d'une autonomie d'environ 20 h, le verre est aux normes de sécurité.

Our brazier has a burn time of around 20 hours, the glass meets safety standards.

Fourni avec sa bouteille de gaz.

Supplied with gas bottle.

42 x 42 X 126 cm

Autonomie : 20 h *Autonomy : 20 h*

Matière : Métal *Material : Metal*

Couleurs : *Colors :*



Solutions chauffantes

Heated solutions



Parasol chauffant

Heated umbrella

En cas de fraîcheur, nos parasols chauffants au gaz seront vos alliés pour des soirées réussies.
If it's chilly, our gas-heated parasols will be your allies for successful evenings.

Fourni avec sa bouteille de gaz.
Supplied with his gas bottle.

ø 76 cm

Hauteur : **230 cm** *Height : 230 cm*

Autonomie : **14 à 26 h** *Autonomy : 14 to 26 h*

Matière : **Inox** *Material : Inox*

Puissance : **8 - 14 kw** *Power : 8 - 14 kw*

Rayonnement : **25 m²** *Radiation : 25 m²*



Chauffage souffleur

Blower heater

Nos chauffages souffleurs professionnels permettent de chauffer des surfaces de plus de 350m².
Our professional blower heaters can heat surfaces of more than 350 m².

Fonctionne au gazole, GNR et fioul.
Runs on diesel, CNG and fuel oil.

135 x 45 x 54 cm

Autonomie : **10 h** *Autonomy : 10 h*

Matière : **Métal** *Material : Metal*

Puissance : **230 v - 45 kw** *Power : 230 v - 45 kw*

Débit : **3000 m³/h** *Flow rate : 3000 m³/h*



Collection
SANITAIRES
MOBILE TOILETS COLLECTION

« *Le confort en toute discrétion* »
« *Hidden comfort* »

Sanitaires

Mobile toilets



En cohérence avec les prestations premium de nos évènements, il nous est apparu évident de répondre à une demande en WC autonomes de haut-standing. Ainsi, nous proposons des solutions simples et adaptées à la qualité de vos réceptions de différentes tailles.

Au sein d'un marché exigeant et au cœur de nouveaux enjeux environnementaux, nous collaborons avec les meilleurs fabricants français afin de proposer des produits esthétiques et qualitatifs. De trois formats différents, nos sanitaires mobiles innovants et élégants répondent avec succès à tous types de réception.

In line with the premium services we offer for our events, it seemed obvious to us to respond to the demand for stand-alone, high-standing WCs. We offer simple solutions tailored to the quality of your receptions of all sizes.

In a demanding market at the heart of new environmental challenges, we work with the best French manufacturers to offer aesthetic, high-quality products. Available in three different formats, our innovative and elegant mobile toilets are the perfect solution for all types of reception.



Évènement jusqu'à **1500** personnes
Events for up to 1500 people



Une flotte de **6** véhicules sanitaires
A fleet of 6 healthcare vehicles



100 prestations par an
100 services per year



BIENVENUE À L'INTÉRIEUR *WELCOME INSIDE*

Des matériaux de fabrication Française, une conception raffinée, un agencement spacieux vous garantissent confort et ergonomie. De plus, tous nos produits d'entretien sont écologiques, respectueux de l'environnement et vous assurent hygiène ainsi que sécurité.

French-made materials, a refined design, a spacious layout guarantee comfort and ergonomics. Moreover, all our cleaning products are ecological, environmentally friendly, ensuring hygiene and safety.



Pour plus d'informations : lepetitcoin-events.com

For more informations : lepetitcoin-events.com

Sanitaires

Mobile toilets



Le Petit Coin 1 + 1

Le Petit Coin 1+1

Longueur : **3,90 m** Length : 3,90 m

Largeur : **2,50 m** Width : 2,50 m

Hauteur : **2,60 m** Height : 2,60 m

Capacité : **Jusqu'à 150 pers** Width : Up to 150 pers



Le Petit Coin 2 + 1

Le Petit Coin 2+1

Longueur : **6,20 m** Length : 6,20 m

Largeur : **2,50 m** Width : 2,50 m

Hauteur : **3 m** Height : 3 m

Capacité : **Jusqu'à 250 pers** Width : Up to 250 pers



Le Petit Coin 3 + 1

Le Petit Coin 3+1

Longueur : **8,20 m** Length : 8,20 m

Largeur : **2,60 m** Width : 2,60 m

Hauteur : **3,10 m** Height : 3,10 m

Capacité : **Jusqu'à 500 pers** Width : Up to 500 pers





VI

Allons plus loin

LET'S GO BEYOND

Façonné pour vous
Made for you

Bureaux

SIMULATIONS 3D

3D SIMULATIONS OFFICES

« Projetez vous dans le décor »

« Project yourself into the setting »

Simulations 3D

3D simulations

Tous nos plans, simulations et autres contenus digitaux pré-événement sont réalisés sur différents logiciels tels que Sketchup, Illustrator ou encore Photoshop afin d'obtenir le résultat le plus réaliste possible.

All our plans, simulations and other pre-event digital content are produced using a range of software such as Sketchup, Illustrator or Photoshop, so that the result is as realistic as possible.

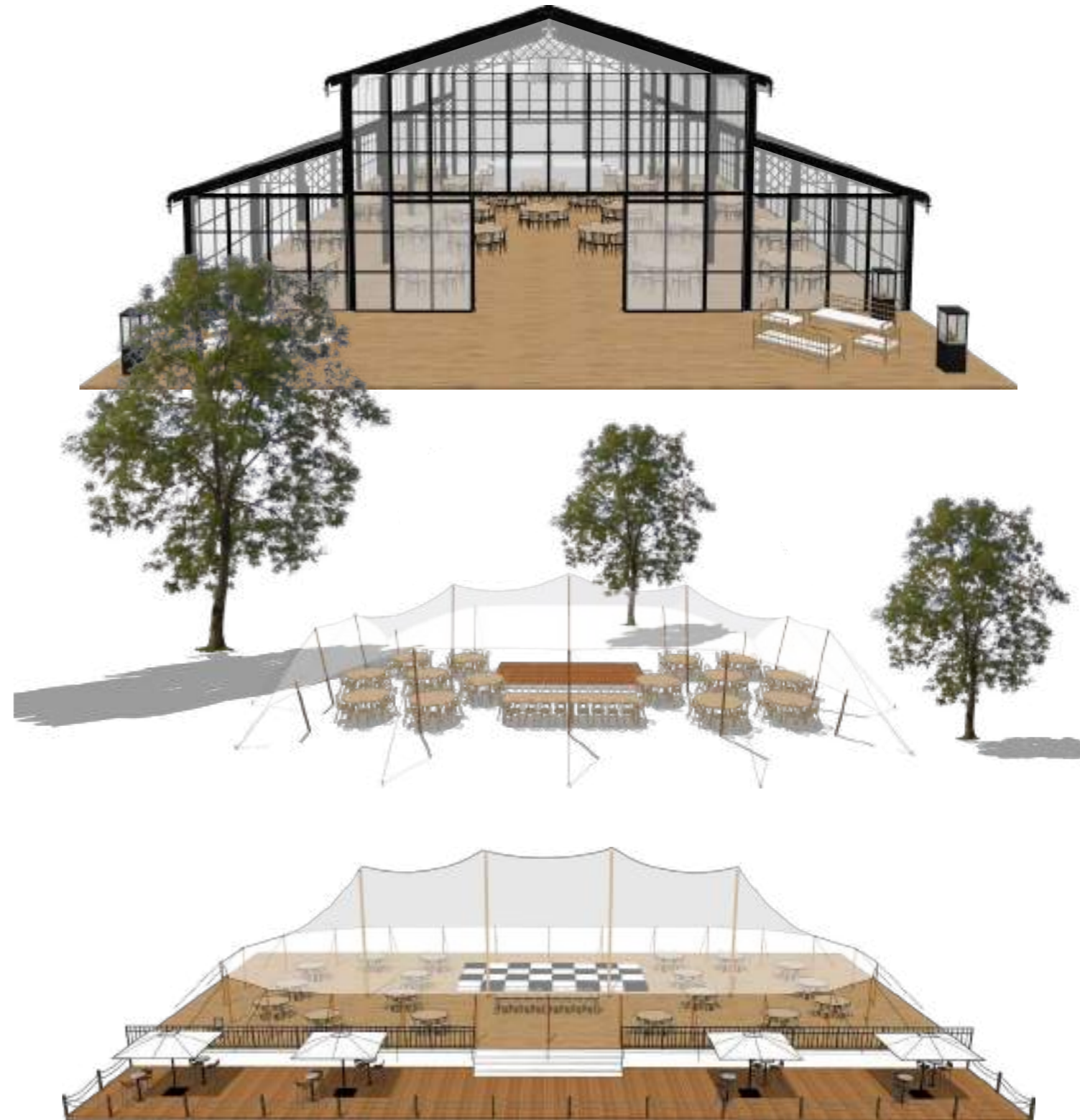
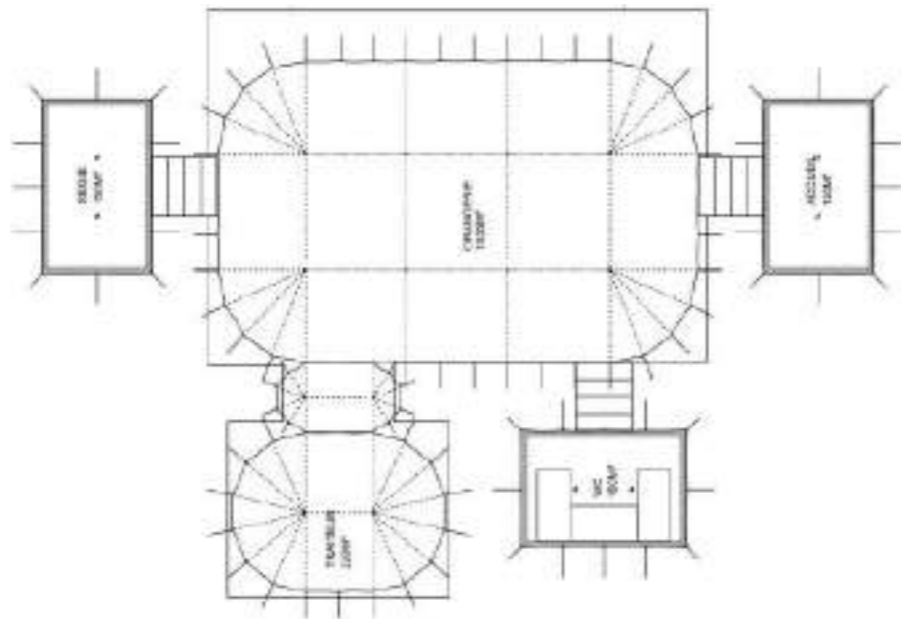

jfd

ORGANISATION



+33 (0)6 72 53 80 22
jfd@jfd.fr

f @ in



jfd.fr