



Location & Décoration événementielle

# CATALOGUE

Collection 2024 / 2025



Alpilles • Grand Avignon • Luberon

Plantez votre décor pour des instants mémorables

*Set the scene for memorable moments*

*Look Book*































Travailler avec passion  
*Work with passion*































L'excellence sur mesure  
*Tailor-made excellence*



















# Tentes & Structures

TENTS & STRUCTURES

*Voyez plus grand*  
Think bigger



Également disponible à la vente  
Also available for sale

Collection  
**TENTE NOMADE**  
NOMADIC STRETCH TENT COLLECTION

« La couverture parfaite »  
« The perfect cover »

LÉGENDE  
KEY



Anti UV  
UV protection



990 g/m<sup>2</sup>  
990 g / m<sup>2</sup>



Étanche  
Waterproof

CTS

Homologué  
Certified



100 km/h de vent  
100 km/h wind



Ignifugé M2  
Fireproof M2



4 cm de neige  
4 cm of snow



Tente Nomade  
Nomadic stretch tent





# Tente Nomade

Nomadic stretch tent

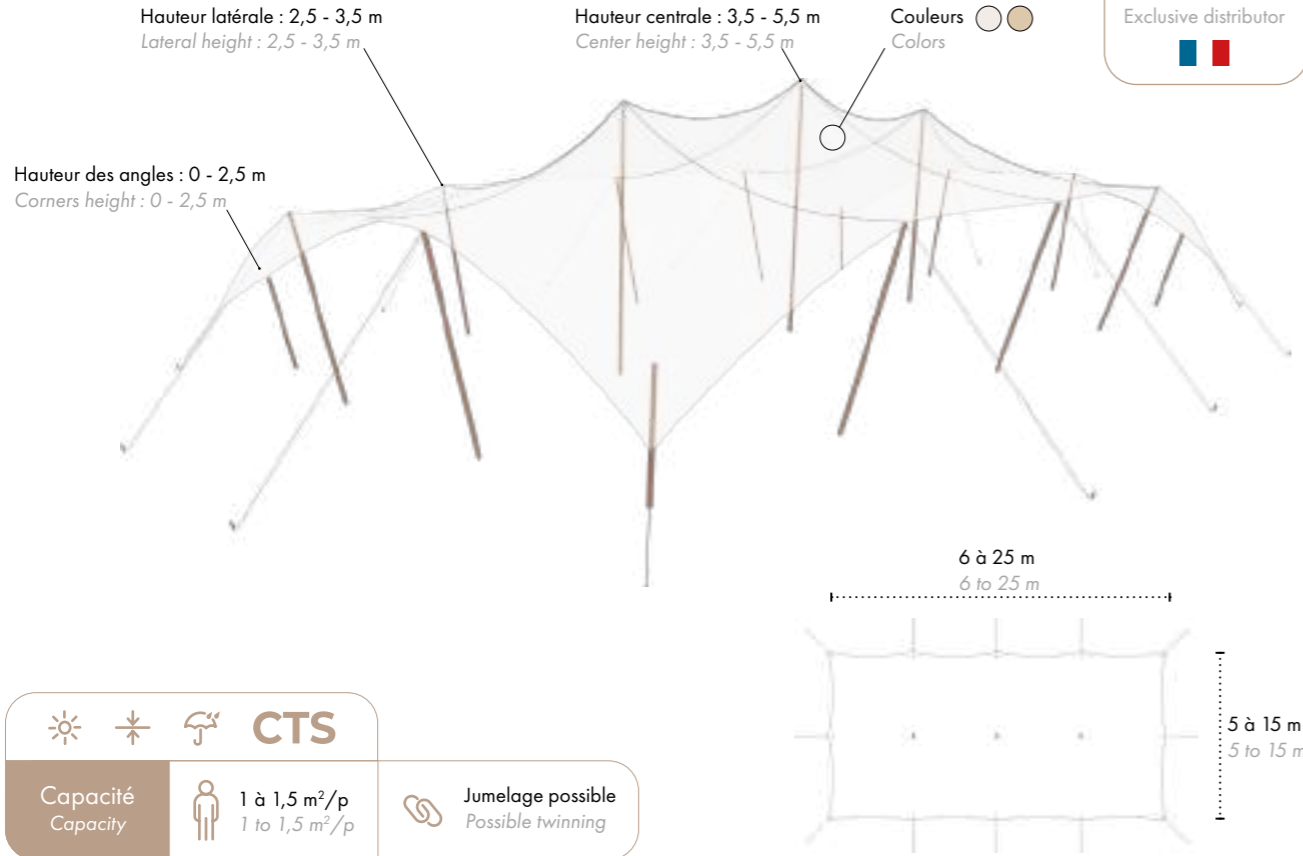

- Toile stretch 4 couches
- Mâts périphériques eucalyptus
- Mâts centraux aluminium habillage beige
- Adaptée à tous types de terrains
- Tailles disponibles : de 30 m<sup>2</sup> à 375 m<sup>2</sup> d'un seul tenant
- 4 layers stretch canvas
- Eucalyptus peripheral poles
- Chino covering aluminium center poles
- Suitable for all types of ground
- Available sizes : from 30 m<sup>2</sup> to 375 m<sup>2</sup> in one piece

## ARRIMAGE STOWAGE

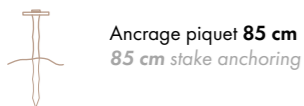

Le montage classique d'une tente nomade nécessite un **ancrage par piquets**. Si le sol ne le permet pas, des lestés seront nécessaires. Il convient également de prévoir **2 m supplémentaires** de chaque côté de la tente, ainsi qu'un **espace dégagé**.

Conventional set ups of stretch tent require **stakes to be used as anchors**. If the ground does not allow this, weights will be needed. You should also allow an extra **2 m** on each side of the tent, as well as a **clear space**.

## OPTION

### HABILLEZ L'INTÉRIEUR DE VOTRE TENTE NOMADE DRESS UP THE INSIDE OF YOUR NOMADIC STRETCH TENT

- Une toile lycra «seconde peau» pour l'intérieur d'une tente nomade
- Modèle "Jungle" disponible en 10 x 20 m
- **Consultez-nous pour une création sur-mesure**
- A "second skin" lycra fabric for the inside of the nomadic tent
- "Jungle" model available in 10 x 20 m
- **Contact us for a custom-made design**



## MONTAGES POSSIBLES POUR TOUTES LES TENTES NOMADES POSSIBLE SET-UPS FOR ALL NOMADIC STRETCH TENTS

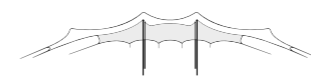

Air



4 x 4

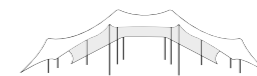

Open

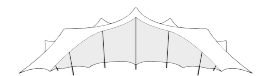

Pavillon



Tente Nomade  
*Nomadic stretch tent*





# Tente Nomade Octogonale

Octagonal Nomadic stretch tent

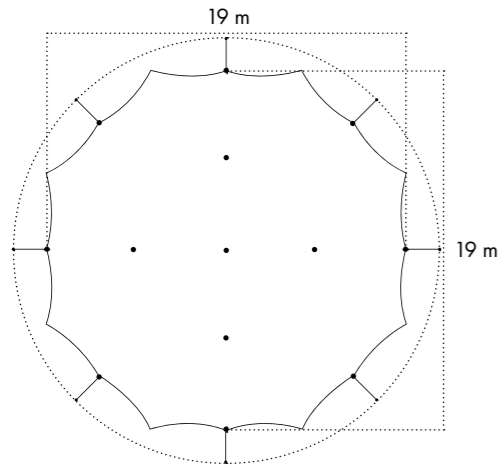

PETITE SOEUR  
LITTLE SISTER

290 m<sup>2</sup>

∅ 19 m / Hauteur : 4,50 m Height : 4,50 m

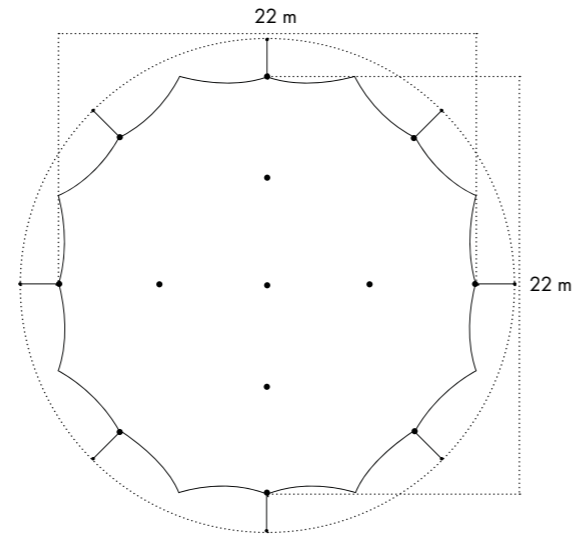

GRANDE SOEUR  
BIG SISTER

380 m<sup>2</sup>

∅ 22 m / Hauteur : 5,50 m Height : 5,50 m

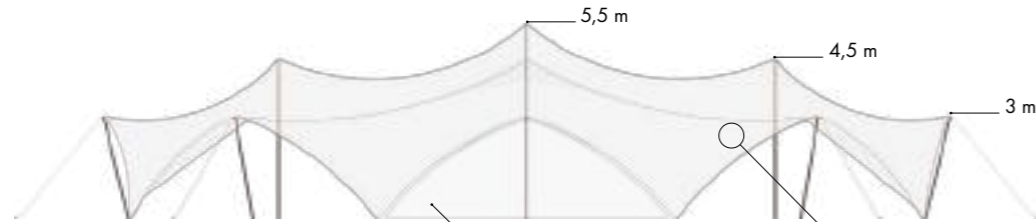

☀	❄	☔	<b>CTS</b>
Capacité Capacity	🧑	1,5 m <sup>2</sup> /p	

Parois en option, vitrées ou opaques  
Optional walls, glazed or opaque

Couleurs  
Colors

## ARRIMAGE STOWAGE



Ancrage piquet 85 cm  
85 cm stake anchoring



Lestage béton par hauban  
Concrete ballast per pole  
1 - 2 t

Le montage classique d'une tente nomade octogonale nécessite un **ancrage par piquets**. Si le sol ne le permet pas, des lests seront nécessaires. Il convient également de prévoir **2 m supplémentaires** de chaque côté de la tente, ainsi qu'un **espace dégagé**.

Conventional set ups of octagonal stretch tent require **stakes to be used as anchors**. If the ground does not allow this, weights will be needed. You should also allow an extra **2 m on each side of the tent**, as well as a **clear space**.

Retrouvez tous les attributs de notre tente nomade combinés en une forme octogonale. De plus, ses 8 angles au sol garantiront une robustesse accrue. Sa forme originale est certes plus exigeante en matière d'espace disponible, mais elle donnera à votre événement une dimension toute aussi majestueuse.

All the attributes of our nomadic tent combined in an octagonal shape. Moreover, its 8 angles to the ground will guarantee extra sturdiness. Its original shape may require more space, but it will give your event an equally majestic dimension.





Également disponible à la vente  
Also available for sale

Collection  
**ORANGERIE NOMADE**  
SAILCLOTH TENT COLLECTION

« Protégez ce qui est précieux »  
« Protect what's precious »

LÉGENDE  
KEY



Anti UV  
UV protection



700 g/m<sup>2</sup>  
700 g / m<sup>2</sup>



Étanche  
Waterproof

CTS

Homologué  
Certified



100 km/h de vent  
100 km/h wind



Ignifugé M2  
Fireproof M2



4 cm de neige  
4 cm of snow



Orangerie Nomade  
*Sailcloth tent*





# Orangerie Nomade

Sailcloth tent

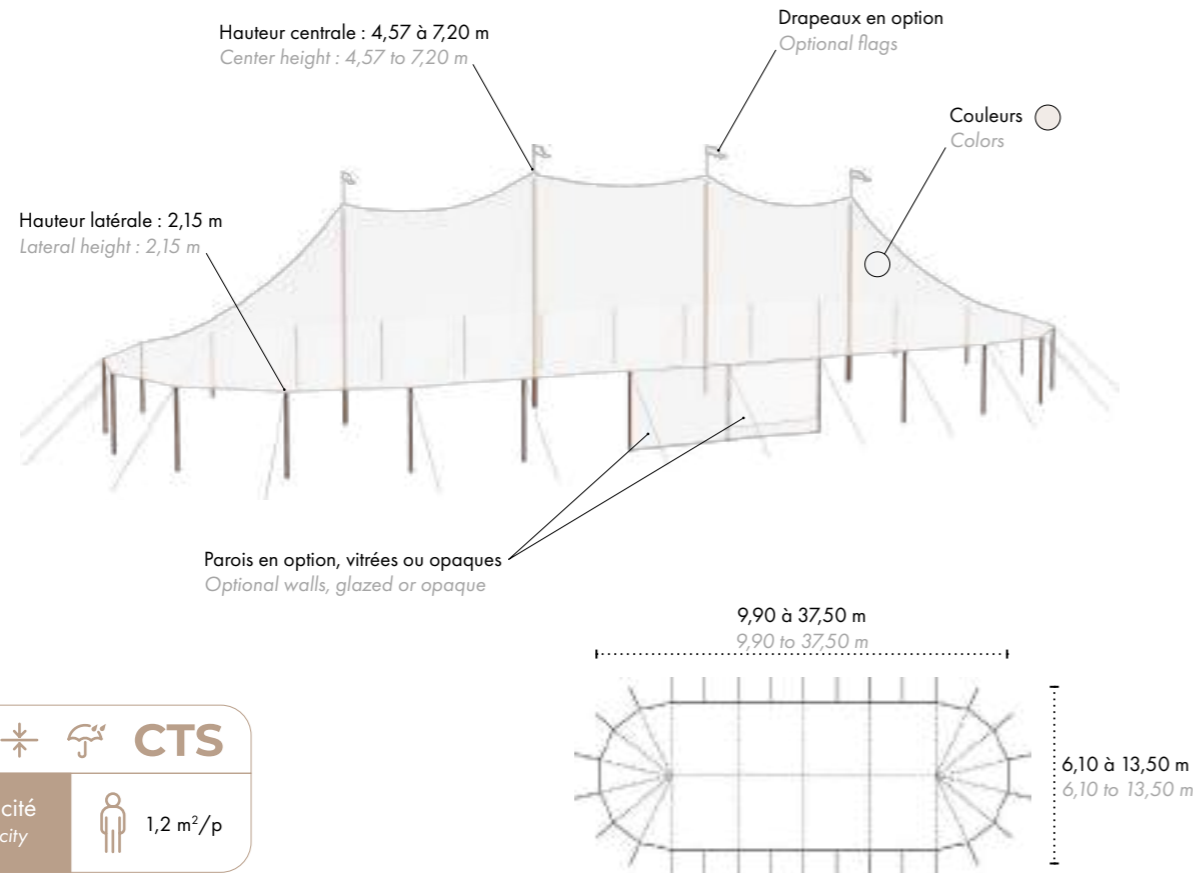

- Toile inspirée de la voilerie américaine
- Mâts au choix : bois pin massif ou aluminium habillé
- Entièrement fermable avec ses parois en PVC souples
- Forme ovale originale
- Chauffage en option

- Canvas inspired by American sailmaking
- Poles choice : solid pin wood or dressed aluminium
- Fully closable with flexible PVC walls
- Original oval shape
- Optional heating

## ARRIMAGE STOWAGE

 Ancrage piquet 85 cm  
85 cm stake anchoring

 Lestage béton par hauban  
Concrete ballast per pole  
1-2 t

Le montage d'une orangerie nomade nécessite un **ancrage par piquets**, toutefois, si le sol ne le permet pas, des lests seront nécessaires. Il convient également de prévoir **2 m supplémentaires** de chaque côté de la tente, ainsi qu'un **espace dégagé**.

Conventional set ups of sailcloth tent require **stakes to be used as anchors**, but if the ground does not allow this, ballast weights will be required. You should also allow an extra **2 m on each side of the tent**, as well as a **clear space**.



MODÈLE DE LARGEUR 6,10 M  
6.10 M WIDE MODEL



Idéale pour votre réception en **intimité** ou en **office traiteur** à relier à votre espace, grâce à notre structure de connexion.

*Ideal for intimate receptions or as a catering office to be connected to your space, thanks to our connection structure.*



Orangerie Nomade  
Sailcloth tent



MODÈLE DE LARGEUR 9,90 M  
9.90 M WIDE MODEL



**70 m<sup>2</sup>**  
9,40 x 9,90 x 5,48 m

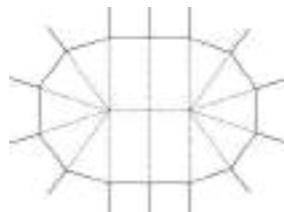

**130 m<sup>2</sup>**  
15,30 x 9,90 x 5,48 m

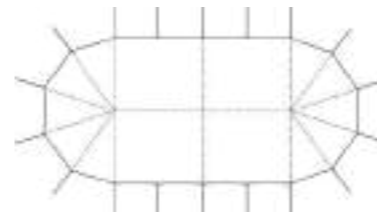
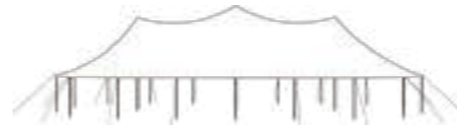

**190 m<sup>2</sup>**  
21,20 x 9,90 x 6,13 m



**250 m<sup>2</sup>**  
27,10 x 9,90 x 6,13 m



# Orangerie Nomade

Sailcloth tent



MODÈLE DE LARGEUR 13,50 M  
13.50 M WIDE MODEL

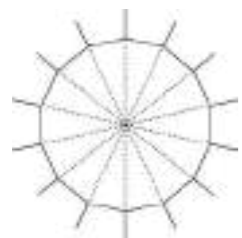

**140 m<sup>2</sup>**  
13,50 x 13,50 x 6,40 m

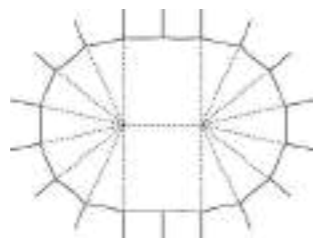

**220 m<sup>2</sup>**  
19,20 x 13,50 x 6,40 m

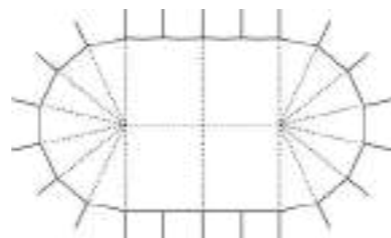
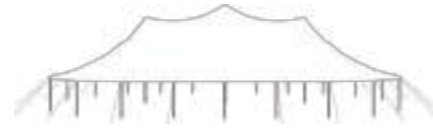

**310 m<sup>2</sup>**  
25,50 x 13,50 x 7,30 m

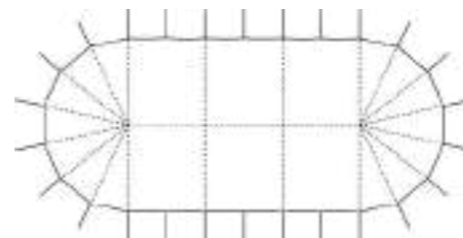

**390 m<sup>2</sup>**  
31,10 x 13,50 x 7,30 m

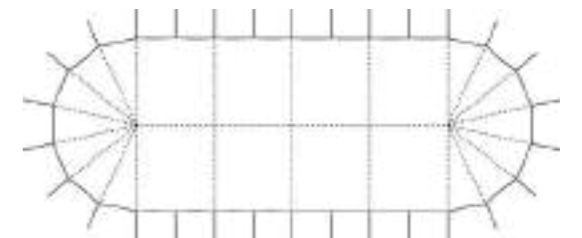
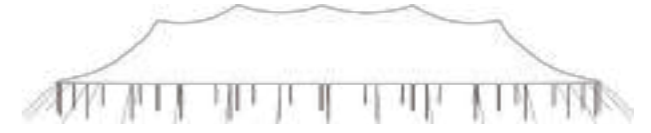

**470 m<sup>2</sup>**  
37,50 x 13,50 x 7,30 m



Collection

# ORANGERIE ABYSSALE

« ABYSSAL » SAILCLOTH TENT COLLECTION

« L'espace, c'est le luxe absolu »  
« Space is the ultimate luxury »

LÉGENDE  
KEY



Anti UV  
UV protection



700 g/m<sup>2</sup>  
700 g / m<sup>2</sup>



Étanche  
Waterproof

CTS

Homologué  
Certified



100 km/h de vent  
100 km/h wind



Ignifugé M2  
Fireproof M2



4 cm de neige  
4 cm of snow



Orangerie Abyssale  
«Abyssal» sailcloth tent





# Orangerie Abyssale

«Abyssal» sailcloth tent

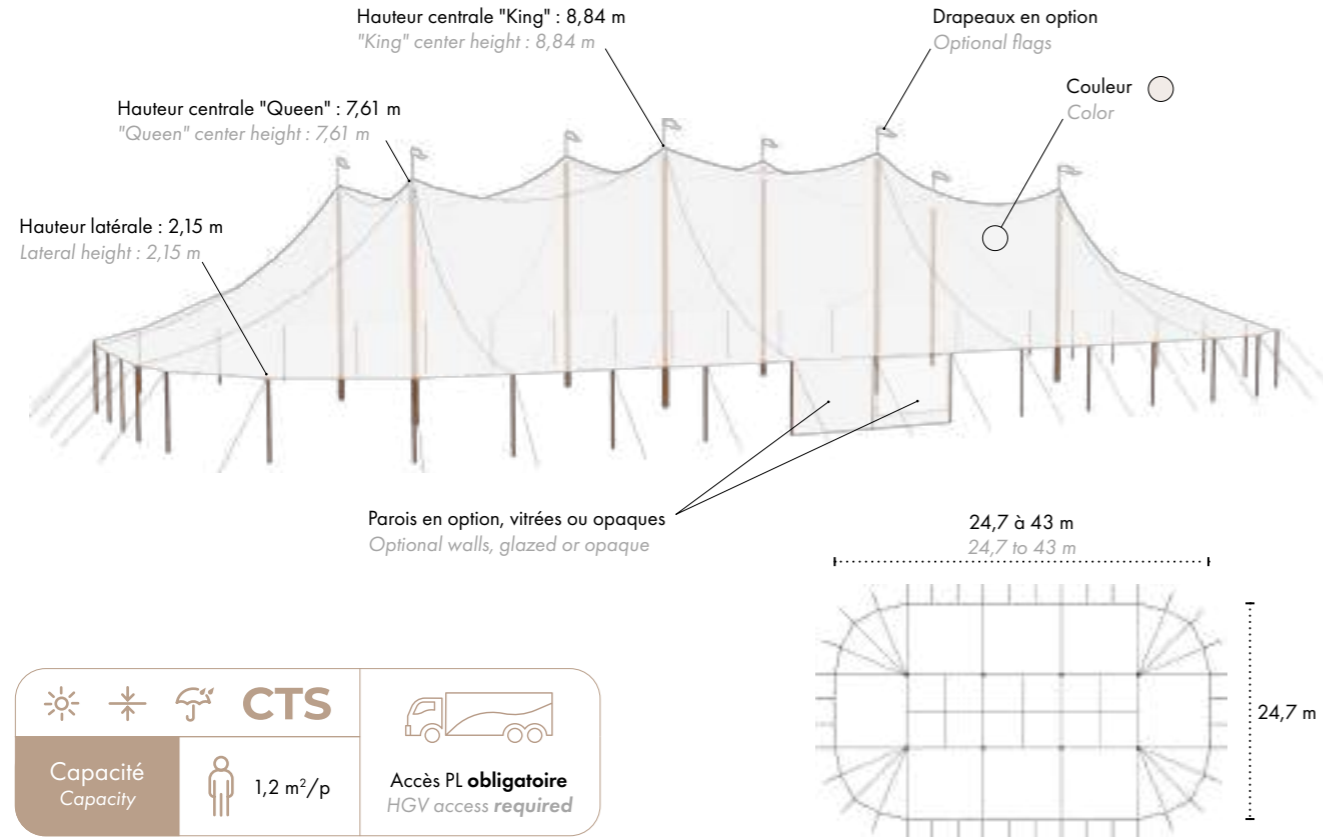

- Notre plus grande structure jusqu'à 1025 m<sup>2</sup>
- Toile inspirée de la voilerie américaine
- Immense hauteur sous plafond (8,84 m)
- Mâts au choix : bois pin massif ou aluminium habillé
- Entièrement fermable avec ses parois en PVC souple
- Forme originale
- Chauffage en option

- Our largest structure up-to 1025 m<sup>2</sup>
- Canvas inspired by American sailmaking
- Immense ceiling height (8,84 m)
- Poles choice : solid pin wood or dressed aluminium
- Fully closable with flexible PVC walls
- Original shape
- Optional heating

## ARRIMAGE STOWAGE



Ancrage piquet 115 cm  
115 cm stake anchoring

Le montage d'une orangerie abyssale nécessite impérativement un **ancrage par piquets**. Il convient également de prévoir **2 m supplémentaires** de chaque côté de la tente, ainsi qu'un **espace dégagé**.

Conventional set ups of "abyssal" sailcloth tent **must be anchored with stakes**. You should also allow an extra **2 m on each side of the tent**, as well as a **clear space**.





# Orangerie Abyssale

«Abyssal» sailcloth tent

ORANGERIE ABYSSALE 575 M<sup>2</sup>  
575 M<sup>2</sup> «ABYSSAL» SAILCLOTH TENT

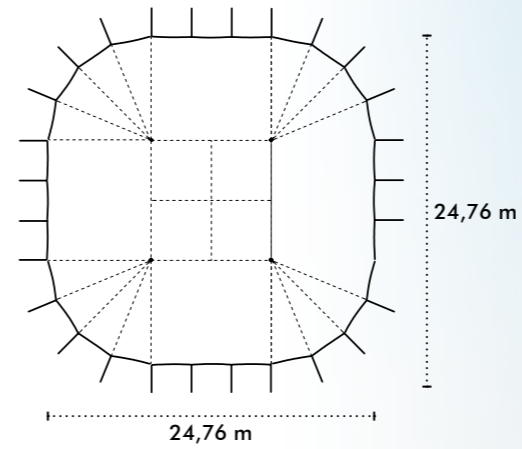

ORANGERIE ABYSSALE 800 M<sup>2</sup>  
800 M<sup>2</sup> «ABYSSAL» SAILCLOTH TENT

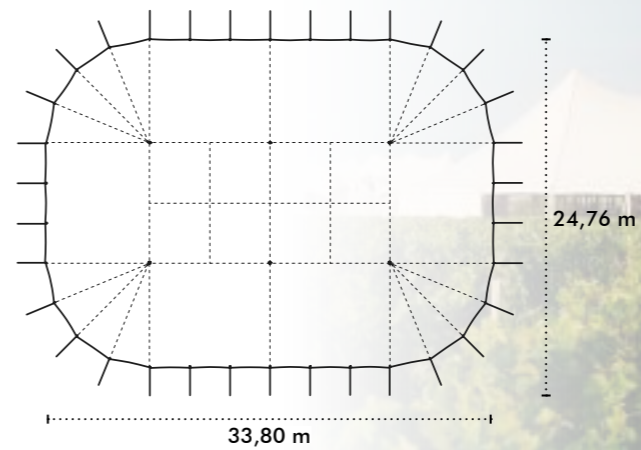

ORANGERIE ABYSSALE 1025 M<sup>2</sup>  
1025 M<sup>2</sup> «ABYSSAL» SAILCLOTH TENT

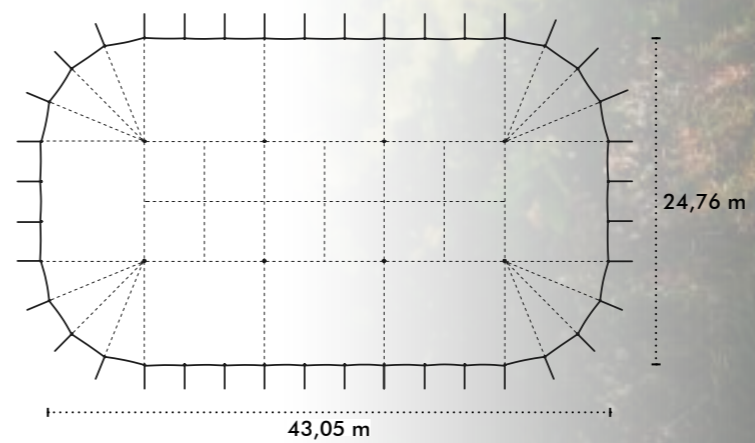



Orangerie Abyssale  
«Abyssal» sailcloth tent





Également disponible à la vente  
Also available for sale

Collection  
**TENTE VERRIÈRE**  
« VERRIÈRE » STRUCTURE COLLECTION

« En toute transparence »  
« In full transparency »

LÉGENDE  
KEY



Anti UV  
UV protection



Étanche  
Waterproof

CTS

Homologué  
Certified



100 km/h de vent  
100 km/h wind



Ignifugé M2  
Fireproof M2



4 cm de neige  
4 cm of snow



Tente Verrière  
«Verrière» structure





# Tente Verrière

«Verrière» structure

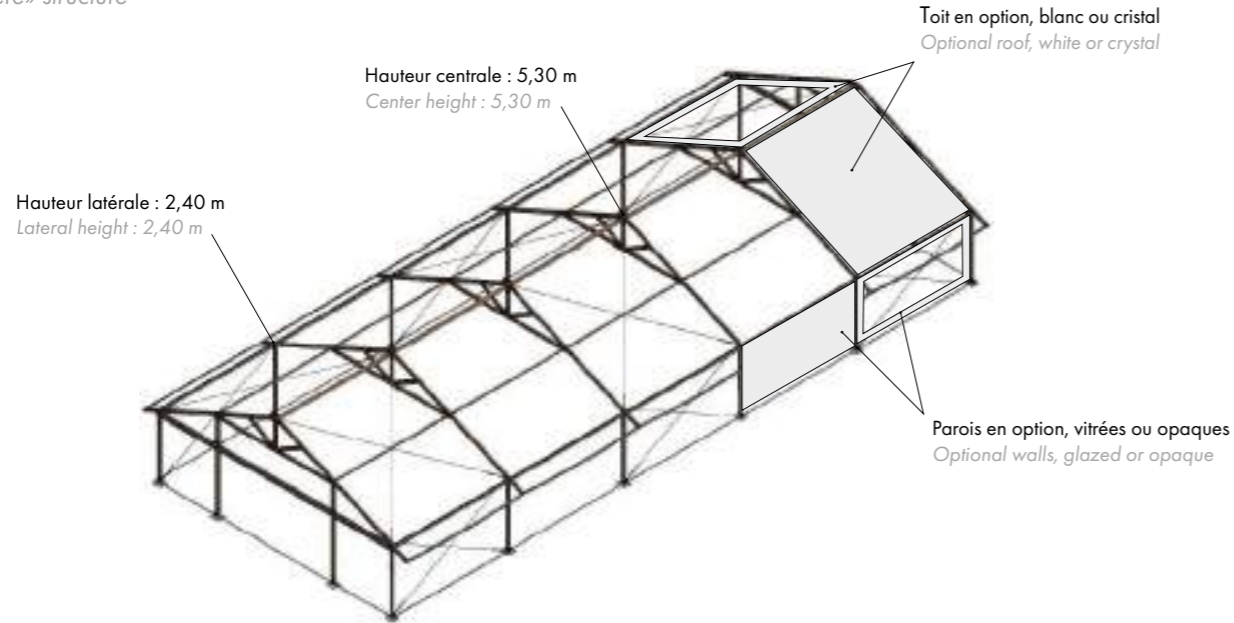

☀️ ☂️	<b>CTS</b>	
Capacité Capacity	 1,2 m <sup>2</sup> /p	Accès PL <b>obligatoire</b> HGV access required

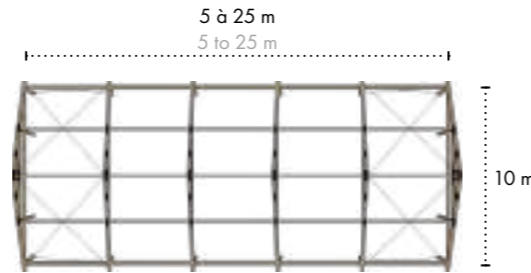

- Fabrication française
- Structure autoportée
- Ossature aluminium thermolaquée, effet bois
- Entièrement fermable, toit et parois en PVC souple
- Lumineuse grâce à sa transparence totale
- Chauffage en option

- French manufacture
- Self-supporting structure
- Powder-coated aluminium structure, wood effect
- Fully closable, flexible PVC roof and walls
- Bright thanks to its total transparency
- Optional heating

## ARRIMAGE STORAGE

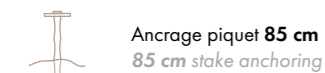

Le montage d'une tente verrière nécessite un **ancrage par piquets**, toutefois, si le sol ne le permet pas, des lests seront nécessaires.

Conventional set ups of "verrière" tent require **stakes to be used as anchors**, but if the ground does not allow this, ballast weights will be required.



## ASSEMBLAGE DE MODULE DE 50 À 250 M<sup>2</sup> MODULE ASSEMBLY FROM 50 TO 250 M<sup>2</sup>

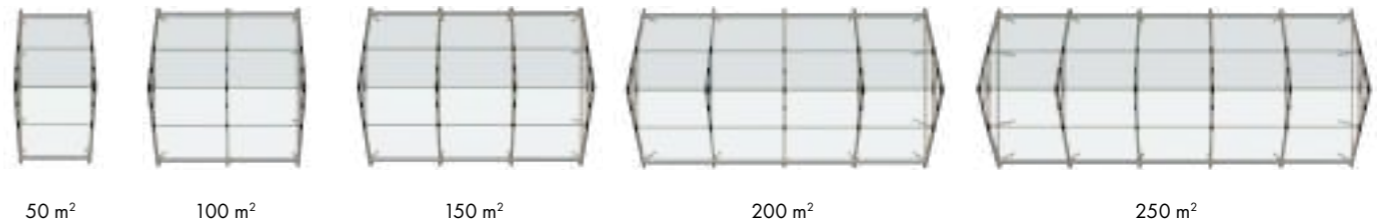



Tente Verrière  
"Verrière" structure





Collection

# GRAND PALAIS VITRÉ

GREENHOUSE « GRAND PALAIS » COLLECTION

« Harmonie sous verre »  
« Harmony under glass »

LÉGENDE  
KEY



Ventilation  
Ventilation



Anti UV  
UV protection



Étanche  
Waterproof



Clim reversible  
A/C

CTS

Homologué  
Certified



100 km/h de vent  
100 km/h wind



Ignifugé M2  
Fireproof M2



4 cm de neige  
4 cm of snow



Grand Palais Vitré  
Greenhouse «Grand Palais»





# Grand Palais Vitré

Greenhouse «Grand Palais»

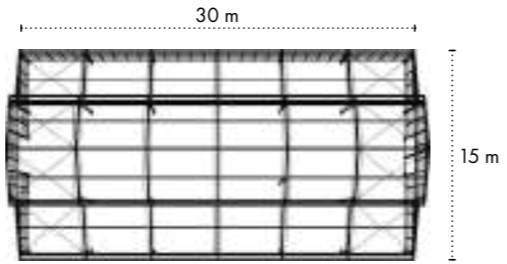
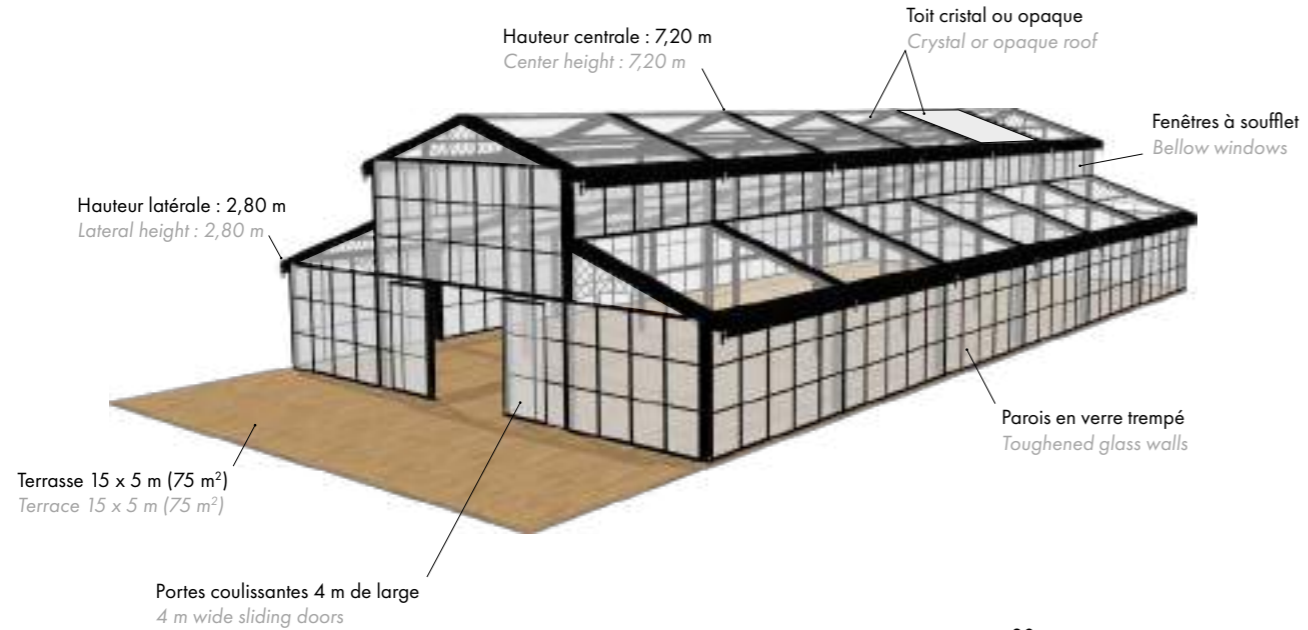

Capacité  
Capacity

1,2 à 1,5 m<sup>2</sup>/p  
1,2 to 1,5 m<sup>2</sup>/p

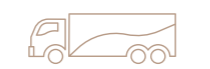

Accès PL obligatoire  
HGV access required

- Structure entièrement modulable et extensible
- Entièrement vitrée (trempé 6 mm)
- Vue à 360° - luminosité exceptionnelle
- Ossature en aluminium noir
- Lustres et ventilation en option
- Toutes saisons

- Fully adjustable and extendable structure
- Fully glazed (6 mm toughened glass)
- 360° view - exceptional brightness
- Black aluminium structure
- Optional chandeliers and ventilation
- All-weather

## ARRIMAGE STOWAGE

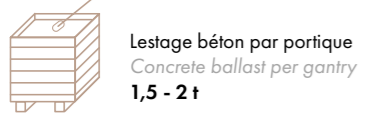

Le montage du grand palais vitré nécessite un **ancrage par piquets**, toutefois, si le sol ne le permet pas, des lestés seront nécessaires.

Conventional set ups of greenhouse "grand palais" require **stakes to be used as anchors**, but if the ground does not allow this, ballast weights will be required.

## MODÈLE DE LARGEUR 15 M 15 M WIDE MODEL



450 m<sup>2</sup>  
30 x 15 x 7,20 m

## MODÈLE DE LARGEUR 11 M 11 M WIDE MODEL



330 m<sup>2</sup>  
30 x 11 x 7,20 m

## MODÈLE DE LARGEUR 7 & 8 M 7 & 8 M WIDE MODEL



210 m<sup>2</sup>  
30 x 7 x 7,20 m



240 m<sup>2</sup>  
30 x 8 x 4,40 m

## LONGUEUR MODULABLE ADJUSTABLE LENGTH



**Modules de 5 m de long amovibles**  
Removable 5 m long modules



*Collection*  
STRUCTURES ILLUMINÉES  
ILLUMINATED STRUCTURES COLLECTION

« Brillez par votre originalité »  
« Shine brightly »

LÉGENDE  
KEY



60 km/h de vent  
60 km/h wind



LED  
LED



Faible consommation  
Low consumption



IP65 étanche  
IP65 waterproof







# Structures illuminées

Illuminated structures

CUBE INDIEN  
INDIAN CUBE

CÔNE INDIEN  
INDIAN CONE

Hauteur : 4,5 à 5,70 m  
Height : 4,5 to 5,70 m

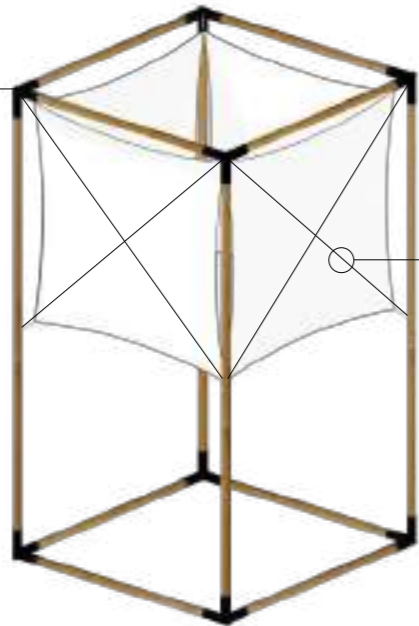

Couleur  
Color

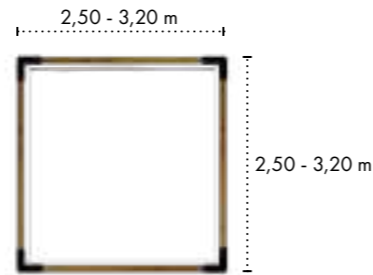

Capacité Capacity		1 à 10 1 to 10	

- Une création Be Lounge
- Structure bambou
- Toile micro-perforée
- Guirlandes blanc chaud
- A Be Lounge creation
- Bamboo structure
- Micro-perforated fabric
- Warm white garlands

GRAND MODÈLE  
LARGE MODEL

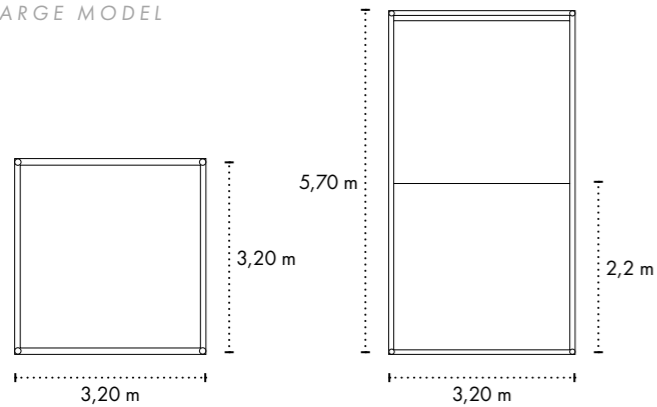

PETIT MODÈLE  
SMALL MODEL

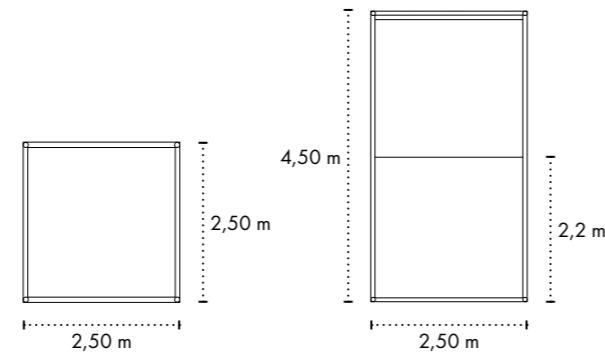

Hauteur : 4,5 m  
Height : 4,5 m



Couleur  
Color

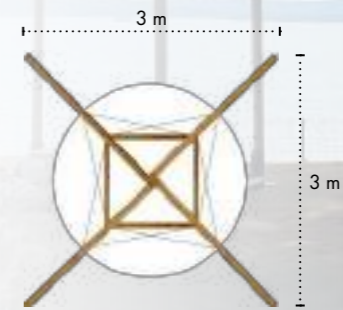

Capacité Capacity		1 à 10 1 to 10	

- Structure bambou
- Guirlande blanc chaud
- Toile haute densité
- Bamboo structure
- Warm white garland
- High density canvas

MODÈLE STANDARD  
STANDARD MODEL

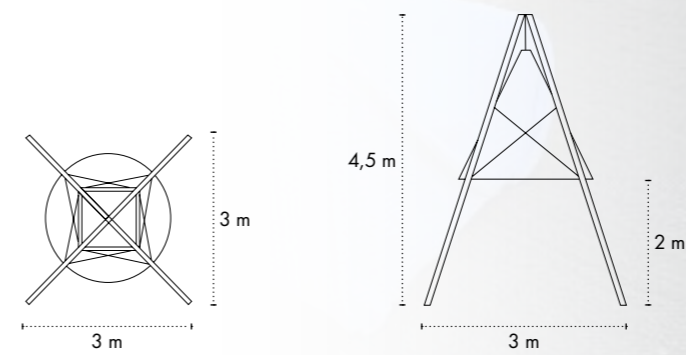



Structures illuminées  
*Illuminated structures*





*Collection*  
AMÉNAGEMENTS EXTÉRIEURS  
EXTERIOR FITTINGS COLLECTION

« Transformez votre environnement »  
« Change your environment »

LÉGENDE  
KEY



Anti UV  
UV protection



Étanche  
Waterproof



100 km/h de vent  
100 km/h wind



Ignifugé DIN 4102  
Fireproof DIN 4102



## Aménagements extérieurs

Exterior fittings



### Voile d'ombrage scourtin

Scourtin shade sail

Support : **Bambou naturel** Support : *Natural bamboo*

Ancrage : **Piquets** Anchoring : *Stakes*

Matière : **Scourtin** Material : *Scourtin*

Couleur : *Color :*



Taille disponible : *Available size :*

4 x 4 x 3 m (16 m<sup>2</sup>)



### Voile d'ombrage lycra

Lycra shade sail

Support : **Bambou naturel** Support : *Natural bamboo*

Ancrage : **Piquets** Anchoring : *Stakes*

Matière : **Lycra** Material : *Lycra*

Couleur : *Color :*



Taille disponible : *Available size :*

4 x 4 x 3 m (16 m<sup>2</sup>)





## Aménagements extérieurs

Exterior fittings



### Pergola / Houppa

*Pergola / Houppa*

Support : **Bambou naturel** *Support : Natural bamboo*

Ancrage : **Piquets** *Anchoring : Stakes*

Matière : **Voilage** *Material : Veiling*

Tailles disponibles : *Available sizes :*

3 x 3 x 3 m (**9m<sup>2</sup>**)

4 x 4 x 2,5 m (**16 m<sup>2</sup>**)

**Existe aussi en chevron bois foncé.**

*Also available in dark wood herringbone.*



### Pagode / Office traiteur

*Pagoda / Catering office*

Hauteur latérale : **2,25 m** *Lateral height : 2,25 m*

Hauteur centrale : **3,5 m** *Central height : 3,5 m*

Matière : **Polyester 520 g** *Material : Polyester 520 g*

Option : **Plancher** *Option : Wooden floor*

Couleur : *Color:*



Tailles disponibles : *Available sizes :*

2 x 4 x 3,5 m (**8 m<sup>2</sup>**)

4 x 4 x 3,5 m (**16 m<sup>2</sup>**)







# III

## Mobilier

FURNITURE

*Confort & raffinement*

Comfort and sophistication



Collection  
**CHAISES**  
CHAIRS COLLECTION

« Pour être irremplaçable, il faut être différent »  
« To be irreplaceable, you have to be different »

LÉGENDE  
KEY



Empilable  
Stackable



Pliable  
Foldable



Nouveau  
New



Naturel  
Natural



Verni  
Varnish



Huilé  
Oiled



# Chaises

Chairs



## Chaise Enora noire

*Black Enora chair*

Bois naturel, peinture noire finition satin, assise et dossier en rotin naturel.

*Natural wood, black satin paint finish, natural rattan seat and back.*

**41 x 44 x 86 cm**

Hauteur assise : **46,5 cm** *Seat height : 46,5 cm*

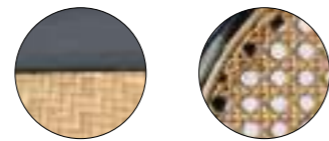

## Chaise Enora blanche

*White Enora chair*

Bois naturel, peinture blanche finition satin, assise et dossier en rotin naturel.

*Natural wood, white satin paint finish, natural rattan seat and back.*

**41 x 44 x 86 cm**

Hauteur assise : **46,5 cm** *Seat height : 46,5 cm*





# Chaises

Chairs



## Chaise Pauline

Pauline chair

Bois naturel, finition patine huilée.  
**Galette type lin sable comprise.**  
*Natural wood, oiled patina finish.*  
*Sand flax type seat cushion included.*

**39,5 x 41,5 x 90 cm**

Hauteur assise : **47 cm** *Seat height : 47 cm*



## Chaise Adèle

Adèle chair

Bois naturel, finition patine huilée.  
**Galette type lin népal comprise.**  
*Natural wood, oiled patina finish.*  
*Nepal flax type seat cushion included.*

**39 x 39,5 x 97 cm**

Hauteur assise : **47 cm** *Seat height : 47 cm*

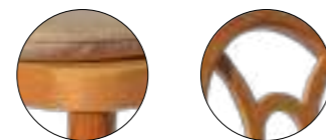



# Chaises

Chairs



## Chaise Médaille Louise

*Louise Medallion chair*

Bois naturel, finition vernis couleur chêne, dossier blanc écru.

**Galette blanc écru comprise.**

*Natural wood, oak varnish finish, unbleached white back. Off white seat cushion included.*

**45 x 49 x 96 cm**

Hauteur assise : **50 cm** *Seat height : 50 cm*

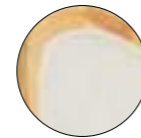

## Chaise Médaille dos canné

*Medallion cane back chair*

Bois naturel, finition vernis vieilli, dossier en rotin naturel.

**Galette blanc écru comprise.**

*Natural wood, aged varnish finish, natural rattan back. Off white seat cushion included.*

**45,5 x 48 x 98 cm**

Hauteur assise : **51 cm** *Seat height : 51 cm*

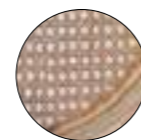



# Chaises

Chairs



## Chaise Mahaut

Mahaut chair

Bois naturel, finition vernis couleur chêne, siège et dossier en rotin synthétique.

*Natural wood, oak varnish finish, synthetic rattan seat and back.*

**40,5 x 40,5 x 77,5 cm**

Hauteur assise : **45 cm** *Seat height : 45 cm*

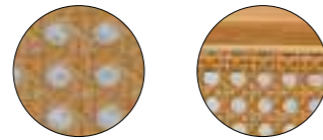

## Chaise Napoléon

Napoleon chair

Bois naturel, finition patine huilée.

**Galette type lin népal comprise.**

*Natural wood, oiled patina finish.*

*Nepal flax type seat cushion included.*

**41 x 38,5 x 91 cm**

Hauteur assise : **46 cm** *Seat height : 46 cm*





# Chaises

Chairs



## Chaise Fermob

Fermob chair

Acier, peinture blanche. Lattes en bois vernis couleur chêne.

**Galette blanche en option.**

Steel, white paint. oak-coloured varnished wooden slats.  
Optional white seat cushion.

29 x 38 x 80 cm

Hauteur assise : 47 cm Seat height : 47 cm

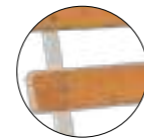

## Chaise Anna

Anna chair

Bois de hêtre, finition vernis, design nordique.

**Galette molletonnée écru en option.**

Beech wood, varnished finish, nordic design.  
Optional cream fleece seat cushion.

53,5 x 55 x 80 cm

Hauteur assise : 45 cm Seat height : 45 cm





# Chaises

Chairs



## Chaise Camille

Camille chair

Bois naturel, blanc patiné.

**Galette blanche comprise.**

Natural wood, aged white finish.

White seat cushion included.

40 x 40 x 92 cm

Hauteur assise : 45 cm Seat height : 45 cm



## Chaise Julia

Julia chair

Bois naturel, finition vernis couleur chêne.

**Assise rembourrée en rotin naturel.**

Natural wood, oak varnish finish.

Padded seat in natural rattan.

41 x 41 x 91 cm

Hauteur assise : 45,5 cm Seat height : 45,5 cm





*Collection*  
**TABOURETS & BANCS**  
STOOLS & BENCHES COLLECTION

« L'élégance est dans les détails qui ne se voient pas »  
« Elegance is in the details that don't show »

LÉGENDE  
KEY



Empilable  
Stackable



Pliable  
Foldable



Nouveau  
New



Naturel  
Natural



## Tabourets & bancs

Stools & benches



### Tabouret Victoria

*Victoria stool*

Acier, finition peinture noire,  
patine légèrement dorée.

*Steel, black paint finish,  
light golden patina.*

**31 x 31 x 77 cm**

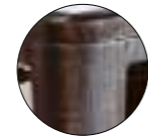

### Tabouret Paris bistrot

*Paris bistrot stool*

Structure en rotin naturel, assise tressée,  
finition couleur blanc et cappucino.

*Natural rattan structure, woven seat,  
white and cappuccino finish.*

**ø 35 cm**

**Hauteur : 76 cm** *Height : 76 cm*

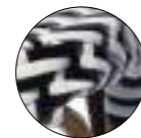



## Tabourets & bancs

Stools & benches



### Tabouret Laurane

Laurane stool

Assise et dossier en bois naturel, structure métal.  
Natural wood seat and back, metal structure.

**33 x 46 x 101 cm**

Hauteur assise : **78 cm** Seat height : 78 cm



### Banc Léon

Léon bench

Assise et structure en bois rustique.  
Seat and structure in rustic wood.

**200 x 36 x 45 cm**





*Collection*  
**TABLES À MANGER**  
DINING TABLES COLLECTION

« *La simplicité est l'ultime sophistication* »  
« *Simplicity is the ultimate sophistication* »

LÉGENDE  
KEY



Pliable  
Foldable



Naturel  
Natural



Bois noble  
Noble wood



Verni  
Varnish



## Tables à manger

Dining tables



### Table rectangulaire Ethnicraft en chêne

*Rectangular Ethnicraft wooden table*

Bois de chêne massif naturel, finition vernis. **Ne nécessite aucun nappage.**  
*Natural solid oak, varnished finish. No tablecloth required.*

**240 x 100 x 75 cm**



**8 à 10 personnes**  
*8 to 10 people*



# Ethnicraft

## Le charme du bois massif

*The charm of solid wood*

Ethnicraft est le spécialiste du mobilier en bois brut. Fabriquées en bois de chêne, vernies, nos tables mettront en valeur votre décoration. D'une qualité et d'une finition irréprochables, elles s'accordent avec toute notre gamme de chaises.

*Ethnicraft is the specialist in raw wood furniture. Made from oak and varnished, our tables will enhance your decor. With their impeccable quality and finish, they match our entire range of chairs.*



Tables à manger  
Dining tables





## Un design authentique

*Authentic design*

Depuis vingt-cinq ans, Ethnicraft crée des meubles contemporains et intemporels à partir de bois massif et de matériaux naturels. Notre collection donne la priorité à ce que nous pensons être l'essence d'un design de qualité : des pièces de caractère, fabriquées à partir de matériaux nobles qui s'embelliront avec le temps.

*For twenty-five years, Ethnicraft has been creating contemporary, timeless furniture from solid wood and natural materials. Our collection focuses on what we believe to be the essence of quality design : pieces with character, made from noble materials that will embellish over time.*

Ethnicraft



### Table ronde Ethnicraft en chêne

*Round Ethnicraft wooden table*

Bois de chêne massif naturel, finition vernis. **Ne nécessite aucun nappage.**  
*Natural solid oak, varnished finish. No tablecloth required.*

ø 160 cm

Hauteur : 75 cm *Seat height : 75 cm*



**6 à 8 personnes**  
*6 to 8 people*



Tables à manger  
*Dining tables*





## Tables à manger

Dining tables



### Table Wagon chêne bi-centenaire

Oak bi-centennial wagon table

Bois de chêne vieilli de 200 ans, finition vernis. **Ne nécessite aucun nappage.**  
200 year old oak, varnished finish. *No tablecloth required.*

200 x 80 x 75 cm



**6 à 8 personnes**  
6 to 8 people





Tables à manger  
Dining tables





## Tables à napper

Polypropylene tables

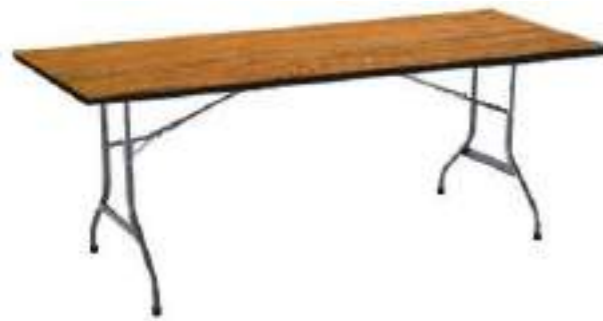

## Table rectangulaire

Rectangular table

Plateau en polypropylène, ossature acier.

**Disponible avec un plateau en bois.**

Polypropylene tray, steel structure.

Available with a wooden top.

 **x6** 182 x 76 x 75 cm

 **x8** 200 x 90 x 74 cm  
200 x 100 x 74 cm



## Table d'honneur

Honor table

Plateau en polypropylène, ossature acier.

Polypropylene tray, steel structure.

Longueur : **Sur-mesure** Length : Custom-made

Largeur : **148 cm** Width : 148 cm

Hauteur : **75 cm** Height : 75 cm

 **x6 - 28**

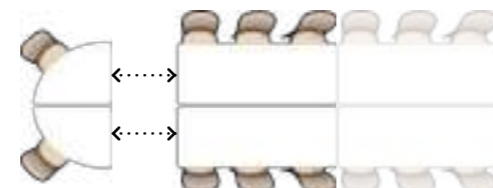

## Table ronde

Round table

Plateau en polypropylène, ossature acier.

Polypropylene tray, steel structure.

 **x8** ø 150 cm  
Hauteur : **75 cm** Height : 75 cm

 **x10** ø 180 cm  
Hauteur : **75 cm** Height : 75 cm

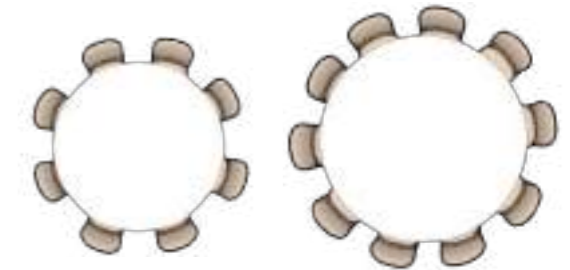

## Table buffet

Buffet table

Plateau en polypropylène, ossature acier.

**Hauteur réglable.**

Polypropylene tray, steel structure.

Adjustable height.

**182 x 75 x 75/90 cm**





*Collection*  
**COINS SALON**  
LOUNGE SETS COLLECTION

« *La mode passe, le style reste* »  
« *Fashion goes, style stays* »

LÉGENDE  
KEY



Nouveau  
New



Naturel  
Natural



Usage extérieur  
Outdoor use



## Coins salon

Lounge sets

# Salon BAMBOU

Notre mobilier Bambou est livré avec ses coussins d'assise gris clair.  
Our Bamboo furniture comes with light grey seat cushions.

Bambou naturel.  
Natural bamboo.



## LE SALON COMPLET FULL SET



x4



x1 (3 places)  
(3 seats)



x1



x8 Coussins « Prestige » inclus  
x8 « Prestige » cushions included



## Le canapé

The sofa

185 x 72,5 x 70 cm

Hauteur assise : 36 cm  
Seat height : 36 cm



## Le fauteuil

The armchair

60 x 72,5 x 70 cm

Hauteur assise : 36 cm  
Seat height : 36 cm



## La table basse

The coffee table

70 x 70 x 45 cm



Coins salon  
Lounge sets





## Coins salon

Lounge sets

# Salon FLORENCE

Notre mobilier Florence est livré avec ses coussins d'assise et dossiers beiges capitonnés.  
*Our Florence furniture comes with upholstered chino seat and back cushions.*

Structure en rotin naturel.  
*Natural rattan fibre structure.*



## LE SALON COMPLET FULL SET



x2



x1 (2 places)  
(2 seats)



x1



## Le canapé

*The sofa*

**92,5 x 52,5 x 72 cm**

Hauteur assise : **37,5 cm**

*Seat height : 37,5 cm*



## Le fauteuil

*The armchair*

**50 x 52,5 x 72 cm**

Hauteur assise : **37,5 cm**

*Seat height : 37,5 cm*



## La table basse

*The coffee table*

**ø 59,5 cm**

Hauteur : **50 cm**

*Height : 50 cm*



Coins salon  
Lounge sets





## Coins salon

Lounge sets

# Salon IPANEMA

Notre mobilier Ipanema est livré avec ses coussins d'assise et dossiers blanc crème.

*Our Ipanema furniture comes with creamy white seat and back cushions.*

Structure en aluminium blanc mat, cordages tressés.

*Structure in matt white aluminium, braided ropes.*



## LE SALON COMPLET FULL SET



x2



x1 (2 places)  
(2 seats)



x2



## Le canapé

*The sofa*

**142 x 57 x 66 cm**

Hauteur assise : **36 cm**

*Seat height : 36 cm*



## Le fauteuil

*The armchair*

**64 x 57 x 66 cm**

Hauteur assise : **36 cm**

*Seat height : 36 cm*



## La table basse

*The coffee table*

**65 x 48 x 30 cm**



Coins salon  
Lounge sets





## Coins salon

Lounge sets

# Salon LOUNGE

Cette collection est le premier né. Elle a meublé plusieurs scénographies de renommée internationale telles que les soirées du gala de l'amfAR durant 6 ans pendant le Festival de Cannes.

*Our Lounge furniture is the very first addition to the Be Lounge collection. It furnished a number of internationally-renowned sets, including the amfAR gala evenings for 6 years during the Cannes Festival.*

Mousse flexible imperméable blanc mat.  
*Waterproof flexible foam in matt white.*



## LE SALON COMPLET FULL SET



**x1 (4 places)**  
(4 seats)



**x2**



**x1 (4 places)**  
(4 seats)



**x1**



## Le canapé

*The sofa*

**160 x 93 x 65 cm**

Hauteur assise : **34 cm**

*Seat height : 34 cm*

## Le banc

*The bench*

**160 x 40 x 35 cm**

## Le pouf

*The pouf*

**40 x 40 x 35 cm**

## La table basse

*The coffee table*

Plateau polycarbonate blanc  
*White polycarbonate tray*

**60 x 60 x 35 cm**

**74 x 74 x 35 cm**



Coins salon  
Lounge sets





## Coins salon

Lounge sets

# Salon CHESTERFIELD

Notre collection Chesterfield est à privilégier pour un usage intérieur.  
*Our Chesterfield collection is ideal for indoor use.*

Mobilier en cuir véritable, vieilli et capitonné.  
*Genuine leather furniture, distressed and upholstered.*



## LE SALON COMPLET FULL SET



x2



x1 (3 places)  
(3 seats)



x2



x1



## Le canapé

*The sofa*

**200 x 90 x 75 cm**

Hauteur assise : 50 cm

*Seat height : 50 cm*



## Le fauteuil

*The armchair*

**115 x 90 x 75 cm**

Hauteur assise : 50 cm

*Seat height : 50 cm*



## Le pouf

*The pouf*

**40 x 40 x 45 cm**



## La table basse

*The coffee table*

**100 x 80 x 47,5 cm**



Coins salon  
Lounge sets





*Collection*  
**MOBILIER D'APPOINT**  
OCCASIONAL FURNITURE COLLECTION

« Terminez en beauté »  
« Finish in style »

LÉGENDE  
KEY



Empilable  
Stackable



Pliable  
Foldable



Nouveau  
New



Naturel  
Natural



## Mobilier d'appoint

Occasional furniture



### Mange-debout Blanc de Blanc

*White of white high table*

Structure en métal finition peinture blanche,  
plateau stratifié.

*Metal structure with white paint finish, laminate top.*

Ø 59 cm

Hauteur : 105 cm *Height : 105 cm*



### Mange-debout Victor

*Victor high table*

Structure en aluminium brossé noir,  
plateau en bois rustique.

*Black brushed aluminium structure, rustic wood top.*

Ø 70 cm

Hauteur : 110 cm *Height : 110 cm*

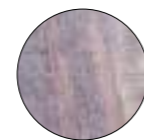



## Mobilier d'appoint

Occasional furniture



### Mange-debout Saint Germain

*Saint Germain high table*

Structure en métal & aluminium stratifié, plateau effet marbre, bord doré.

*Laminated metal & aluminium structure, marble-effect top, gilded edge.*

Ø 60 cm

Hauteur : 115 cm *Height : 115 cm*

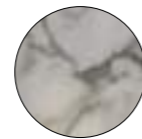

### Mange-debout Teck

*Teak high table*

Structure et plateau en teck verni.

*Varnished teak structure and top.*

70 x 70 x 103 cm





## Mobilier d'appoint

Occasional furniture



### Table basse Léon

*Léon coffee table*

Structure en bois rustique.  
*Rustic wood structure.*

**100 x 80 x 47,5 cm**



### Table haute Léon

*Léon high table*

Structure en bois rustique.  
*Rustic wood structure.*

**225 x 70 x 110 cm**





## Mobilier d'appoint

Occasional furniture



### Guéridon Cooper doré

Golden Cooper pedestal table

Structure en métal & plateau texturé.  
Metal structure & textured top.

ø 70 cm

Hauteur : 75 cm Height : 75 cm



### Guéridon Cooper blanc

White Cooper pedestal table

Structure en métal & plateau texturé.  
Metal structure & textured top.

ø 70 cm

Hauteur : 75 cm Height : 75 cm





## Mobilier d'appoint

Occasional furniture



### Chaise Paris bistrot

Paris Bistro chair

Structure en rotin naturel, assise tressée, finition couleur blanc et cappuccino.

Natural rattan structure, woven seat, white and cappuccino finish.

**53 x 48 x 96 cm**

Hauteur assise : **45 cm** Seat height : 45 cm



### Table bistrot Saint Germain

Saint Germain bistro table

Structure en métal & aluminium stratifié, plateau effet marbre, bord doré.

Laminated metal & aluminium structure, marble-effect top, gilded edge

**70 x 70 x 76 cm**

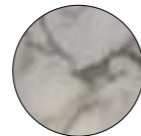



## Mobilier d'appoint

Occasional furniture



### Fauteuil Giverny

*Giverny armchair*

Structure en bois, finition en rotin tressé.

**Disponible en brun et blanc.**

*Wooden structure, woven rattan finish.*

*Available in brown and white.*

**41,5 x 56 x 81 cm**

**Hauteur assise : 45 cm** *Seat height : 45 cm*

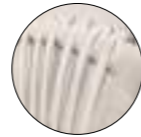

### Chaise longue Chilienne

*Chilienne long chair*

Structure en bambou naturel, assise et dossier en tissu blanc crème.

**Hauteur réglable.**

*Natural bamboo structure, seat and back in creamy white fabric.*

*Adjustable height*

**112 x 60 x 80 cm**

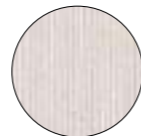



*Collection*  
**BARS & COMPTOIRS**  
BARS & COUNTERS COLLECTION

« *Un cocktail de pièces d'exception* »  
« *A cocktail of exceptional pieces* »

LÉGENDE  
KEY



Pliable  
Foldable



Nouveau  
New



Naturel  
Natural



## Bars & comptoirs

Bars & counters



### Bar Rustique

*Rustique bar*

Structure en bois rustique, plateau en zinc.  
*Rustic wood structure, zinc top.*

#### GRAND MODÈLE

*LARGE MODEL*

180 x 50 x 107 cm



#### PETIT MODÈLE

*SMALL MODEL*

120 x 50 x 107 cm





## Bars & comptoirs

Bars & counters



### Bar Guinguette bois naturel

*Guinguette light wood bar*

Structure en bois couleur brun clair,  
plateau en bois, parois pliables.

*Light slate brown wooden structure, wooden top, folding sides.*

**210 x 80 x 110 cm**



### Bar Guinguette bois blanc

*Guinguette white wood bar*

Structure en bois couleur blanc patiné,  
plateau en bois, parois pliables.

*White weathered wooden structure, wooden top, folding sides.*

**210 x 80 x 110 cm**

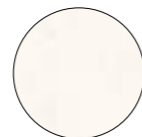



## Bars & comptoirs

Bars & counters



### Bar Rotonde

*Rotonde bar*

Structure et plateau en bois, composée de 3 modules.  
*Wooden structure and top, made up of 3 independent modules.*

Extérieur **ø 3,5 m** *Exterior ø 3,5 m*

Hauteur : **110 cm** *Height: 110 cm*





## Bars & comptoirs

Bars & counters



### Bar Joséphine

*Joséphine bar*

Structure en bois couleur noir ardoise, plateau en cuivre « Rosegold ».

*Slate black structure, « Rosegold » copper tray.*

**180 x 50 x 110 cm**

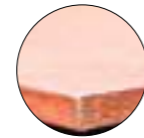

### Étagère fond de bar vintage

*Vintage bar shelf*

Structure en fer, caissons en bois de manguier.

*Iron structure, mango wood boxes.*

**86 x 40 x 187 cm**





## Bars & comptoirs

Bars & counters



### Bar Jeanne

Jeanne bar

Structure en bois couleur blanc, plateau en bois.

Façade en cannage, vitrée.

White wooden structure, wooden top. Cane front, glazed.

180 x 65 x 100 cm

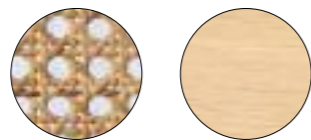





# Éclairage

LIGHTING

*Brillez de mille feux*  
Shine brightly



Collection  
GUIRLANDES  
GARLANDS COLLECTION

« Des étoiles plein les yeux »  
« Stars in the eyes »

LÉGENDE  
KEY



LED  
LED



Dimmable  
Dimmable



Consommation\*  
Consumption\*



IP65 étanche  
IP65 waterproof



Raccordable  
Connectable



## Guirlande Guinguette *Bistro garland*

Modèle ampoules blanc chaud cordon blanc **12 ou 25 m**  
*Transparent bulbs with warm white light white cord model 12 or 25 m*

Modèle ampoules blanc chaud cordon noir **12 ou 25 m**  
*Transparent bulbs with warm white light black cord model 12 or 25 m*



 100 W / 25 m



Nos guirlandes Guinguette sont d'une longueur de 12 ou 25 m. Leurs ampoules LED blanc chaud offriront une lumière qui s'adaptera au mieux à votre espace grâce à leur variateur\*. Vous pourrez modifier l'intensité et choisir de tamiser davantage une fois la fête lancée.

*Our Bistro garlands are 12 or 25 m long. Their warm white LED bulbs offer a light that's perfectly suited to your space, thanks to their dimmer switch\*. You can change the intensity and choose to dim the light even further once the party has started.*

\*Variateur en option  
\*Optional dimmer switch

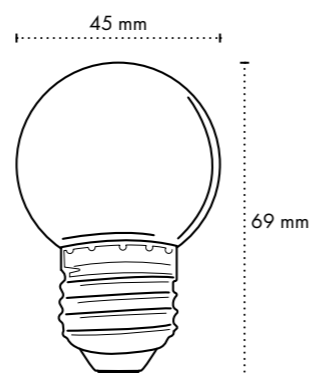

## Guirlande Loupiote *Spark garland*

Modèle ampoules blanc chaud cordon blanc **20 m**  
*Warm white bulbs with a white cord 20 m*

Modèle ampoules blanc chaud cordon noir **20 m**  
*Warm white bulbs with a black cord 20 m*

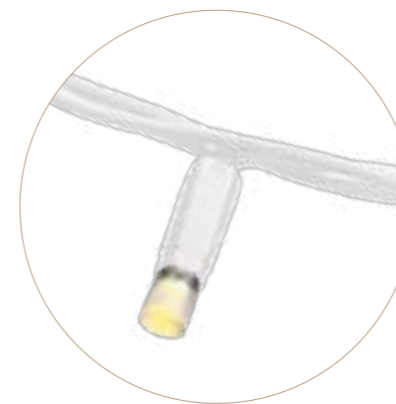

 15 W / 20 m



Nos guirlandes Loupiote, d'une longueur de 20 m, ont un cordon blanc ou noir avec des petites ampoules fines. Elles pourront s'utiliser pour créer des «ciels étoilés» ou encore pour entourer et illuminer les mâts et les arbres. L'éclairage est plus doux et tamisé que les guirlandes classiques.

*Our Spark garlands are 20 m long and have a white or black cord with small, thin bulbs. They can be used to create "starry skies" or to surround and illuminate poles and trees. The lighting is softer and more subdued than traditional garlands.*

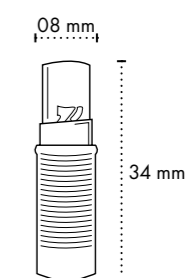



Guirlande Guinguette  
Bistro garland



Guirlande Loupiote  
Spark garland





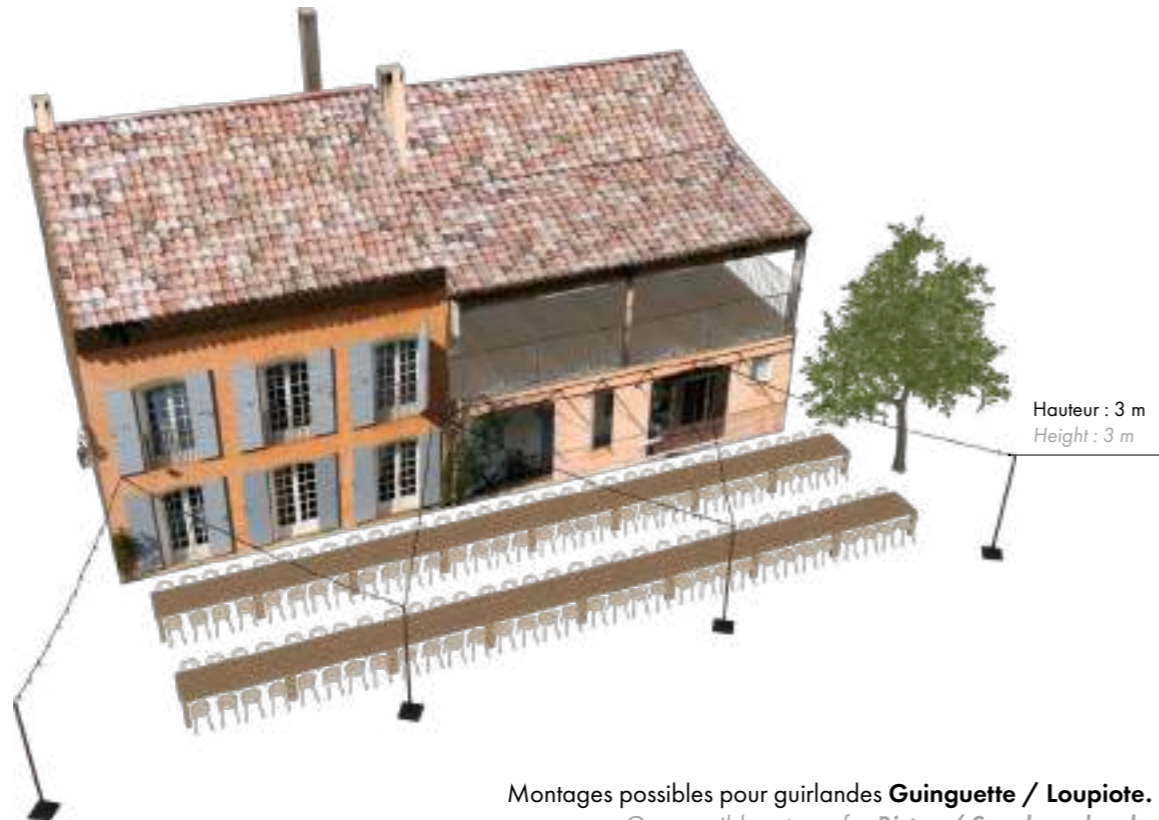
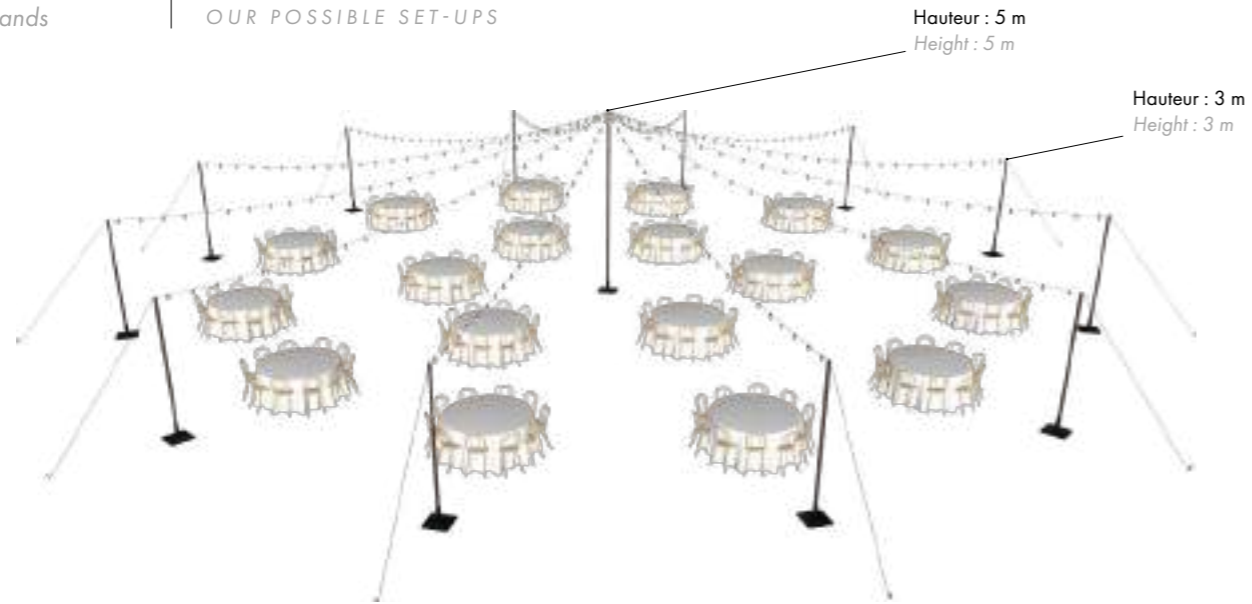

Montages possibles pour guirlandes **Guinguette / Loupiote**.  
Our possible set-ups for **Bistro / Spark** garlands.



**Carrousel de lumière**  
Light carousel

Disponibles en 2 tailles :  
Available in 2 sizes :

ø 12 m (113 m<sup>2</sup>)  
ø 25 m (490 m<sup>2</sup>)

Ancrage : **Piquets ou lestage**

Anchoring : *Stakes or ballast*



**Sur-mesure**  
Custom-made

Disponible dans les dimensions de  
votre choix.  
Available in the dimensions of your choice.

Ancrage : **Piquets ou lestage**

Anchoring : *Stakes or ballast*



# Guirlandes

Garlands

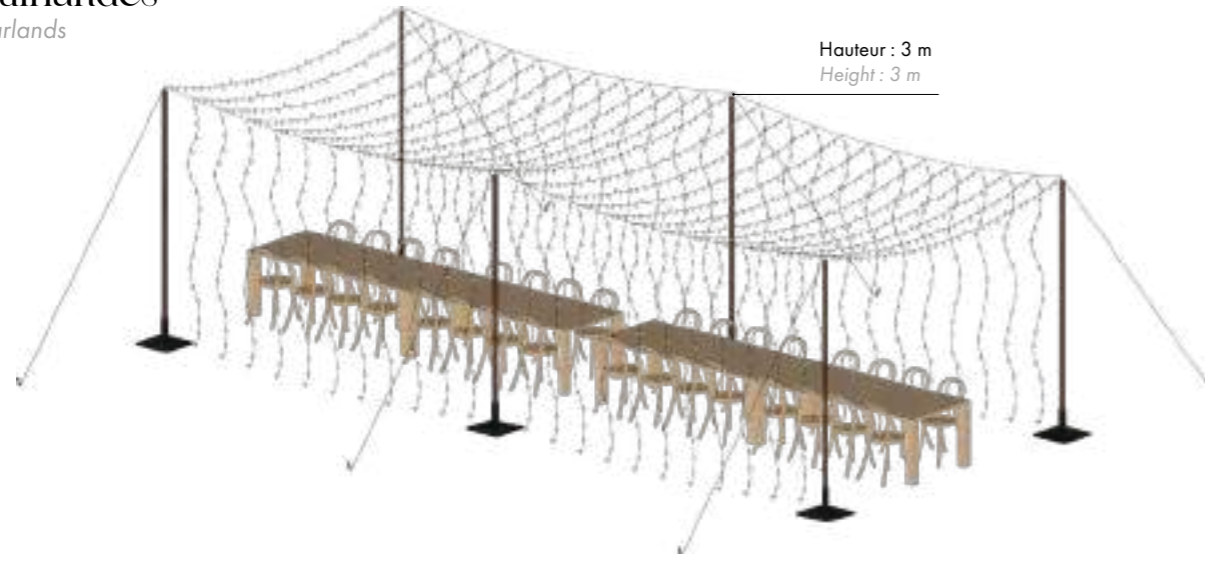

Hauteur : 3 m  
Height : 3 m

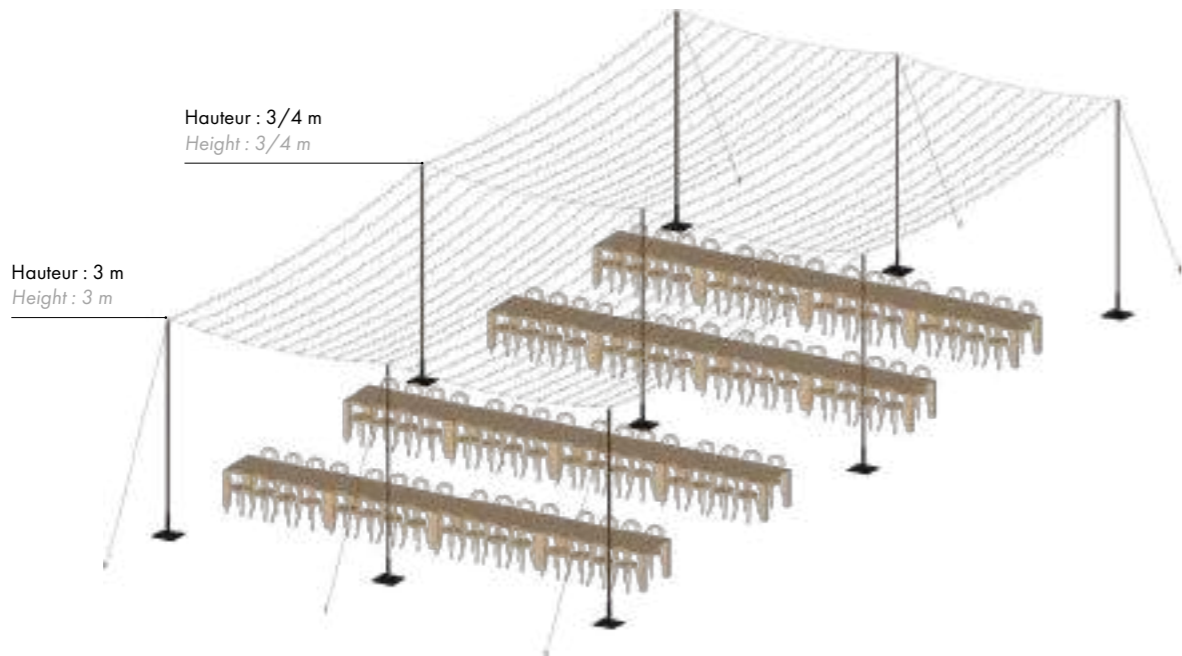

Hauteur : 3/4 m  
Height : 3/4 m

Hauteur : 3 m  
Height : 3 m

Montages possibles pour guirlandes **Loupiote**.  
Our possible set-ups for **Spark garlands**.



## Couloir de Loupiote

Light corridor

Disponible dans les dimensions de votre choix.  
Available in the dimensions of your choice.

Ancrage : **Piquets ou lestage**

Anchoring : *Stakes or ballast*



## Ciel étoilé

Starry sky

Disponible dans les dimensions de votre choix.  
Available in the dimensions of your choice.

Ancrage : **Piquets ou lestage**

Anchoring : *Stakes or ballast*



*Collection*  
**SPOTS AUTONOMES**  
AUTONOMOUS SPOTLIGHTS COLLECTION

« *Et la lumière fut* »  
« *And there was light* »

LÉGENDE  
KEY



LED  
LED



Faible consommation  
Low consumption



IP65 étanche  
IP65 waterproof



Batterie  
Battery



## Spots autonomes

Autonomous spotlights



### Mirage / Color Event

**Pack de 6** Pack of 6

Spot indirect LED RGB programmable (toutes couleurs).  
Fonctionne sur batterie.

**Autonomie de 12h.**

Indirect LED RGB Spotlight programmable (all colors).  
Battery operated. 12h autonomy.

**Idéal pour un éclairage localisé.**

Ideal for a targeted lighting.



### SpotLite

**Pack de 8** Pack of 8

Spot indirect LED RGB programmable (toutes couleurs)  
via application mobile. Fonctionne sur batterie.

**Autonomie de 10 à 14h.**

Programmable indirect RGB LED spotlight (all colors) via mobile  
application. Battery operated, 10 to 14 hours autonomy.

**Idéal pour un éclairage ciblé.**

Ideal for targeted lighting.



### SpotMax

**Pack de 2** Pack of 2

Spot indirect LED RGB programmable (toutes couleurs)  
via application mobile. Fonctionne sur batterie

**Autonomie de 10 à 14h.**

Programmable indirect RGB LED spotlight (all colors) via mobile  
application. Battery operated, 10 to 14 hours autonomy.

**Idéal pour un éclairage puissant.**

Ideal for powerful lighting.





*Collection*  
**ACCESSOIRES LUMINEUX**  
LIGHTING ACCESSORIES COLLECTION

« N'éteignez pas encore la lumière... »  
« Don't turn out the lights yet... »

LÉGENDE  
KEY



LED  
LED



Faible consommation  
Low consumption



Batterie  
Battery



Anti moustiques  
Mosquito repellent



## Accessoires lumineux

Lighting accessories



### Torche nomade

Nomadic torch

Bougie à la citronnelle.

Citronella candle.

Ø 30 cm

Hauteur : 140 cm Height : 140 cm

Matière : Bois, métal et cire Material : Wood, metal and wax

Autonomie : 24 h Autonomy : 24 h



### Sac lanterne

Lantern bag

Faciles à mettre en place grâce aux bougies LED anti-feu.

Easy to set up thanks to the fireproof LED tealights supplied.

12 x 12 x 20 cm

Matière : Papier Material : Paper

Autonomie : 200 h Autonomy : 200 h





## Accessoires lumineux

Lighting accessories

### LUSTRES BALINAIS BALINESE CHANDELIERS

**Paire d'ampoules rechargeables autonomes en option.**  
L'éclairage de chaque lustre est contrôlable avec une télécommande.

*Pair of self-contained rechargeable bulbs in option.*  
*The lighting of each chandelier can be controlled by remote control.*



**Champignon**  
*Mushroom*

**50 x 50 x 50 cm**

Matière : **Rotin** *Material : Rattan*



**Ellipse**  
*Ellipse*

**30 x 30 x 48 cm**

Matière : **Rotin** *Material : Rattan*



**Montgolfière**  
*Hot-air balloon*

**22 x 22 x 50 cm**

Matière : **Rotin** *Material : Rattan*



**Squid**  
*Squid*

**30 x 30 x 110 cm**

Matière : **Rotin** *Material : Rattan*



**Nabuco**  
*Nabuco*

**35 x 35 x 70 cm**

Matière : **Rotin** *Material : Rattan*



**Cône**  
*Cone*

**22 x 22 x 62 cm**

Matière : **Rotin** *Material : Rattan*





# IV

## Revêtements

FLOORING

*Pour le plaisir des talons*  
For the pleasure of heels



*Collection*  
**PLANCHER**  
WOODEN FLOOR COLLECTION

« *Touchez du bois* »  
« Knock on wood »



# Plancher

Wooden floor

Nous garantissons une stabilité parfaite et régulière sur votre terrain avec notre plancher autoporté, muni d'une ossature en acier à double nappe. Nivelé par nos équipes à l'aide de chandelles, ce revêtement permet d'accroître vos espaces de réception et notre stock en sapin brut de plus de 3 000 m<sup>2</sup> devrait vous donner des idées de grandeur !

We guarantee perfect, even stability for your site with our self-supporting, double-layer steel framed flooring. Levelled by our teams using wedge candles, this flooring allows you to expand your reception areas, and our raw fir tree stock of over 3 000 m<sup>2</sup> should give you ideas of size !



## CONFORT OPTIMAL OPTIMUM COMFORT

Dans un souci permanent du détail, le plancher sera entouré de coton gratté ou (film extandex) afin que la structure en acier soit dissimulée.

With an eye for detail, the wooden floor will be surrounded by scraped cotton or (extandex film) to conceal the steel structure.

## TRANSPORT TRANSPORT

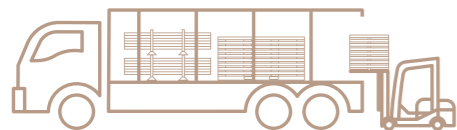

PL 19/26 t + Chariot élévateur 2,7 t  
19/26 t HGV + 2.7 t forklift

Le transport du plancher et sa manipulation nécessitent une **logistique particulièrement importante**. Un repérage technique sera **indispensable** pour confirmer la faisabilité du projet.

Transporting and handling the wooden floor is a **particularly demanding logistical task**. A technical survey is **essential** to confirm the feasibility of the project.

## ZOOM SUR LE PLANCHER ZOOM ON THE WOODEN FLOOR

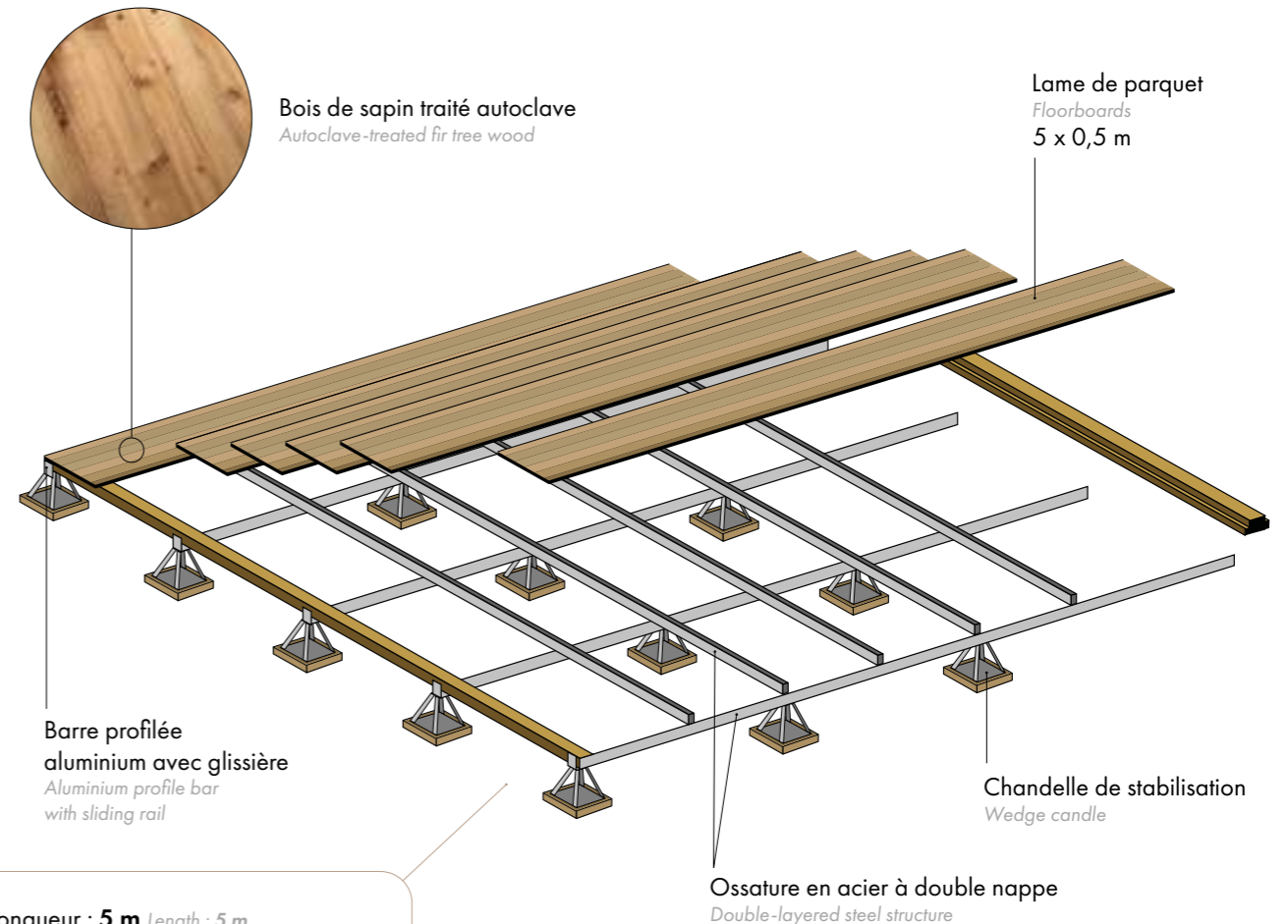

Bois de sapin traité autoclave  
Autoclave-treated fir tree wood

Lame de parquet  
Floorboards  
5 x 0,5 m

Barre profilée  
aluminium avec glissière  
Aluminium profile bar  
with sliding rail

Chandelle de stabilisation  
Wedge candle

Ossature en acier à double nappe  
Double-layered steel structure

Longueur : 5 m Length : 5 m  
Largeur : 5 m Width : 5 m  
Hauteur : 20 à 80 cm Height : 20 to 80 cm

## ANCRAGE ANCHORING



Piquet 85 cm  
85 cm stake



Chandelle 20 à 80 cm  
Wedge candle 20 to 80 cm

Fixation au sol et mise à niveau à l'aide de **chandelles de stabilisation et de piquets**.

Secured to the ground and levelled with **wedge candles and stakes**.







## COLONNES DE STABILISATION STABILISATION COLUMNS

Les colonnes de stabilisation peuvent prendre en charge des sols inclinés et irréguliers jusqu'à 12 degrés au moyen d'une fonctionnalité « d'ajustement d'angle » intégrée à l'ensemble des plaques de base/colonnes primaires.

*Stabilisation columns can handle sloping and uneven floors of up to 12 degrees by means of an « angle adjustment » feature built into the baseplate/primary column assembly.*

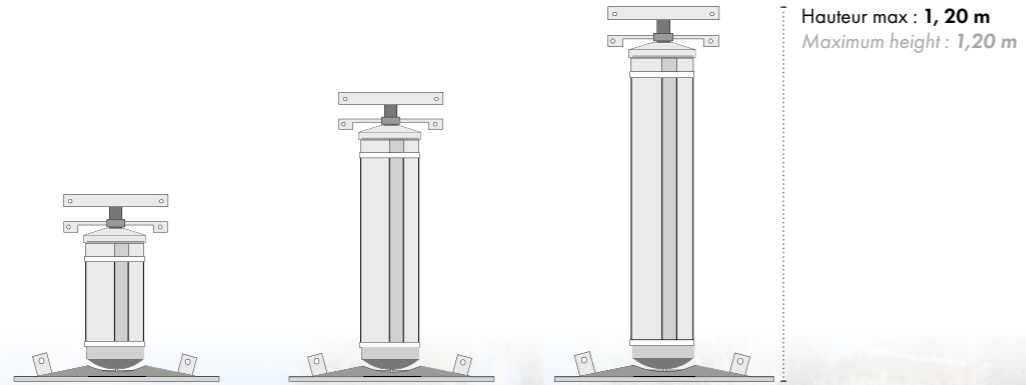



*Collection*

**PISTE DE DANSE**  
DANCEFLOOR COLLECTION

« *Jusqu'au bout de la nuit* »  
« *To the end of the night* »



## Piste de danse

Dancefloor

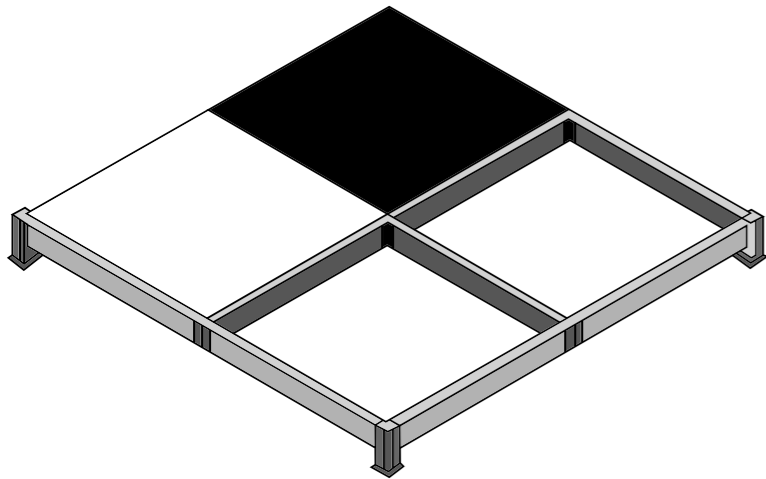
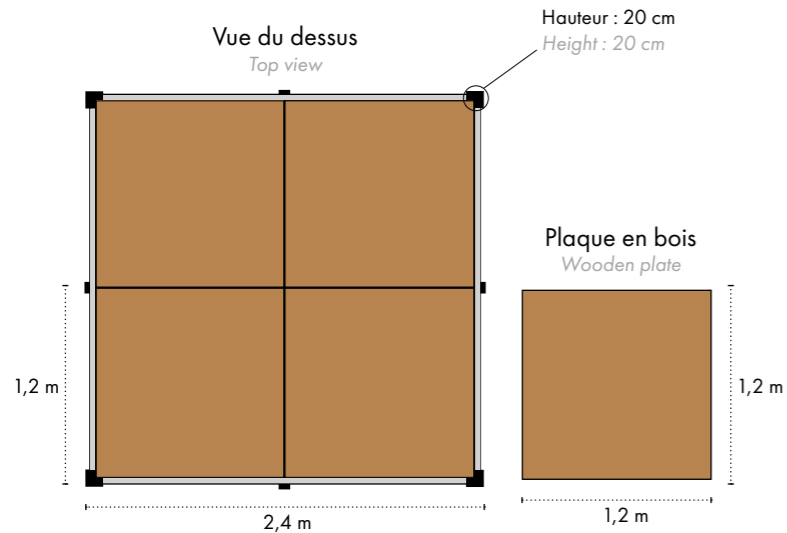

## Bois couleur cognac

Color cognac wood

Plaques de bois, finition huile teintée, posées sur une armature métallique.

Wooden plates, tinted oil finish, laid on a metal frame.

**1,2 x 1,2 x 0,20 m**



## Damier noir & blanc

Black & white checkerboard

Plaques de bois noires/blanches, finition laquée, posées sur une armature métallique.

Black/ white wooden plates, lacquer-finish, laid on a metal frame.

**1,2 x 1,2 x 0,20 m**



### CONFORT OPTIMAL OPTIMUM COMFORT

Dans un souci permanent du détail, la piste sera entourée de coton gratté ou (film extandex) afin que la structure en acier soit dissimulée.

With an eye for detail, the dancefloor will be surrounded by scraped cotton or (extandex film) to conceal the steel structure.



*Collection*

**MOQUETTE & SOL NATUREL**  
CARPET & NATURAL FLOOR COLLECTION

« *Vous savez où vous mettez les pieds* »  
« *You know what you're getting into* »



## Moquette & Sol naturel

Carpet & Natural floor



## Moquette éco-responsable

Eco-responsible carpet

Moquette 100% recyclable.  
Habille toutes les surfaces.  
*100% recyclable carpet. Suitable for all surfaces.*

**Uniquement en complément de location.**  
*Only in addition to rental.*

Longueur : **Sur-mesure** *Length : Custom-made*

Largeur : **2 m** *Width : 2 m*

Matière : **Fibre textile** *Material : Textile fibre*

Poids : **0,71 kg / m<sup>2</sup>** *Weight : 0,71 kg / m<sup>2</sup>*



## Sol naturel

Natural floor

Tapis coco, jonc de mer... Nous sommes en mesure de couvrir toutes surfaces.

**Consultez-nous.**

*Coconut matting, sea rush... We can cover any surface. Just ask.*

**Uniquement en complément de location.**  
*Only in addition to rental.*

Longueur : **Sur-mesure** *Length : Custom-made*

Largeur : **4 m** *Width : 4 m*

Matière : **Fibre naturelle** *Material : Natural fibre*

Poids : **3 kg / m<sup>2</sup>** *Weight : 3 kg / m<sup>2</sup>*





*Collection*  
**ESTRADE**  
STAGE COLLECTION

« Prenez la parole »  
« Make a speech »



# Estrade

Stage

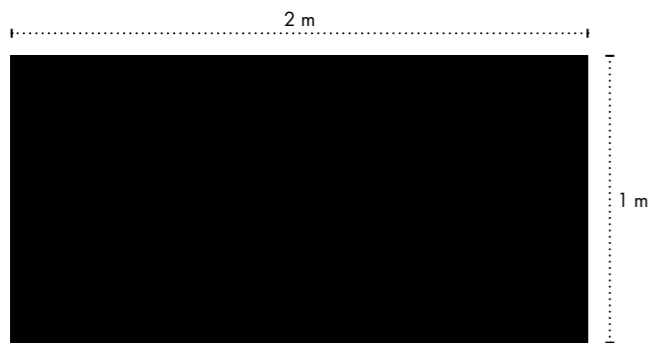
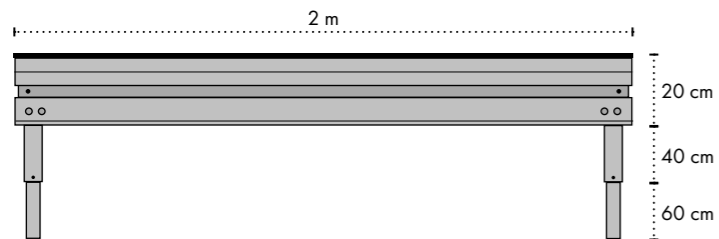
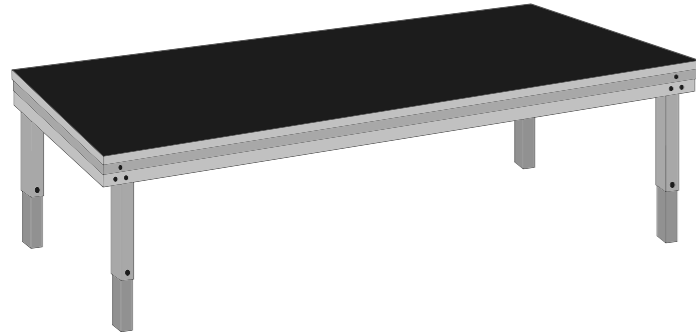

## Estrade

Stage

Pour une animation ou un discours réussi, notre estrade sera parfaite pour créer une scène ou un podium.

*For a successful event or speech, our stage will be perfect for creating a scene or podium.*

**Module :**

**2 x 1 m x 0,20/0,40/0,60 m**

### CONFORT OPTIMAL OPTIMUM COMFORT

Dans un souci permanent du détail, l'estrade sera entourée de coton gratté ou (film extandex) afin que la structure en acier soit dissimulée.

*With an eye for detail, the scene will be surrounded by scraped cotton or (extandex film) to conceal the steel structure.*







**Les petits +**  
LITTLE EXTRAS

*L'importance du détail*  
Attention to detail



*Collection*  
**PARASOLS**  
PARASOLS COLLECTION

« *Ils vous feront de l'ombre* »  
« *They'll overshadow you* »



# Parasols

Parasols



## Parasol Luxe

Luxury parasol

Platine autolestée, structure en eucalyptus, autolift.  
Self-bolting turntable, eucalyptus structure, autolift.

**3 x 3 x 2,57 m**

Couleurs : Colors :



## Parasol Cyclades

Cyclades parasol

Platine autolestée, structure en teck, cordes tressées blanc crème.  
Self-bolting turntable, teak structure, creamy white braided ropes.

**ø 2,5 m**

Hauteur : **2,29 m** Height : 2,29 m





*Collection*

SOLUTIONS CHAUFFANTES  
HEATED SOLUTIONS COLLECTION

« Une ambiance chaleureuse »  
« A warm atmosphere »



## Solutions chauffantes

Heated solutions



### Brasero Marbella

Marbella brazier

Notre brasero bénéficie d'une autonomie d'environ 20 h, le verre est aux normes de sécurité.

*Our brazier has a burn time of around 20 hours, the glass meets safety standards.*

**Fourni avec sa bouteille de gaz.**

*Supplied with gas bottle.*

**42 x 42 X 126 cm**

Autonomie : **20 h** *Autonomy : 20 h*

Matière : **Métal** *Material : Metal*

Couleurs : *Colors :*





## Solutions chauffantes

Heated solutions



### Parasol chauffant

Heated umbrella

En cas de fraîcheur, nos parasols chauffants au gaz seront vos alliés pour des soirées réussies.  
*If it's chilly, our gas-heated parasols will be your allies for successful evenings.*

**Fourni avec sa bouteille de gaz.**  
*Supplied with his gas bottle.*

**ø 76 cm**

Hauteur : **230 cm** *Height : 230 cm*

Autonomie : **14 à 26 h** *Autonomy : 14 to 26 h*

Matière : **Inox** *Material : Inox*

Puissance : **8 - 14 kw** *Power : 8 - 14 kw*

Rayonnement : **25 m<sup>2</sup>** *Radiation : 25 m<sup>2</sup>*



### Chauffage souffleur

Blower heater

Nos chauffages souffleurs professionnels permettent de chauffer des surfaces de plus de 350m<sup>2</sup>.  
*Our professional blower heaters can heat surfaces of more than 350 m<sup>2</sup>.*

**Fonctionne au gazole, GNR et fioul.**  
*Runs on diesel, CNG and fuel oil.*

**135 x 45 x 54 cm**

Autonomie : **10 h** *Autonomy : 10 h*

Matière : **Métal** *Material : Metal*

Puissance : **230 v - 45 kw** *Power : 230 v - 45 kw*

Débit : **3000 m<sup>3</sup>/h** *Flow rate : 3000 m<sup>3</sup>/h*





*Collection*  
**SANITAIRES**  
MOBILE TOILETS COLLECTION

« *Le confort en toute discrétion* »  
« *Hidden comfort* »



## Sanitaires

Mobile toilets



En cohérence avec les prestations premium de nos évènements, il nous est apparu évident de répondre à une demande en WC autonomes de haut-standing. Ainsi, nous proposons des solutions simples et adaptées à la qualité de vos réceptions de différentes tailles.

Au sein d'un marché exigeant et au cœur de nouveaux enjeux environnementaux, nous collaborons avec les meilleurs fabricants français afin de proposer des produits esthétiques et qualitatifs. De trois formats différents, nos sanitaires mobiles innovants et élégants répondent avec succès à tous types de réception.

*In line with the premium services we offer for our events, it seemed obvious to us to respond to the demand for stand-alone, high-standing WCs. We offer simple solutions tailored to the quality of your receptions of all sizes.*

*In a demanding market at the heart of new environmental challenges, we work with the best French manufacturers to offer aesthetic, high-quality products. Available in three different formats, our innovative and elegant mobile toilets are the perfect solution for all types of reception.*



Évènement jusqu'à **1500** personnes  
*Events for up to 1500 people*



Une flotte de **6** véhicules sanitaires  
*A fleet of 6 healthcare vehicles*



**100** prestations par an  
*100 services per year*



## BIENVENUE À L'INTÉRIEUR *WELCOME INSIDE*

Des matériaux de fabrication Française, une conception raffinée, un agencement spacieux vous garantissent confort et ergonomie. De plus, tous nos produits d'entretien sont écologiques, respectueux de l'environnement et vous assurent hygiène ainsi que sécurité.

*French-made materials, a refined design, a spacious layout guarantee comfort and ergonomics. Moreover, all our cleaning products are ecological, environmentally friendly, ensuring hygiene and safety.*



Pour plus d'informations : [lepetitcoin-events.com](https://lepetitcoin-events.com)

*For more informations : [lepetitcoin-events.com](https://lepetitcoin-events.com)*



## Sanitaires

Mobile toilets



### Le Petit Coin 1 + 1

*Le Petit Coin 1+1*

Longueur : **3,90 m** Length : 3,90 m

Largeur : **2,50 m** Width : 2,50 m

Hauteur : **2,60 m** Height : 2,60 m

Capacité : **Jusqu'à 150 pers** Width : Up to 150 pers



### Le Petit Coin 2 + 1

*Le Petit Coin 2+1*

Longueur : **6,20 m** Length : 6,20 m

Largeur : **2,50 m** Width : 2,50 m

Hauteur : **3 m** Height : 3 m

Capacité : **Jusqu'à 250 pers** Width : Up to 250 pers



### Le Petit Coin 3 + 1

*Le Petit Coin 3+1*

Longueur : **8,20 m** Length : 8,20 m

Largeur : **2,60 m** Width : 2,60 m

Hauteur : **3,10 m** Height : 3,10 m

Capacité : **Jusqu'à 500 pers** Width : Up to 500 pers







# VI

## Allons plus loin

LET'S GO BEYOND

*Façonné pour vous*  
Made for you



*Bureaux*

SIMULATIONS 3D  
3D SIMULATIONS OFFICES

« Projetez vous dans le décor »  
« Project yourself into the setting »



# Simulations 3D

3D simulations

Tous nos plans, simulations et autres contenus digitaux pré-événement sont réalisés sur différents logiciels tels que Sketchup, Illustrator ou encore Photoshop afin d'obtenir le résultat le plus réaliste possible.

All our plans, simulations and other pre-event digital content are produced using a range of software such as Sketchup, Illustrator or Photoshop, so that the result is as realistic as possible.

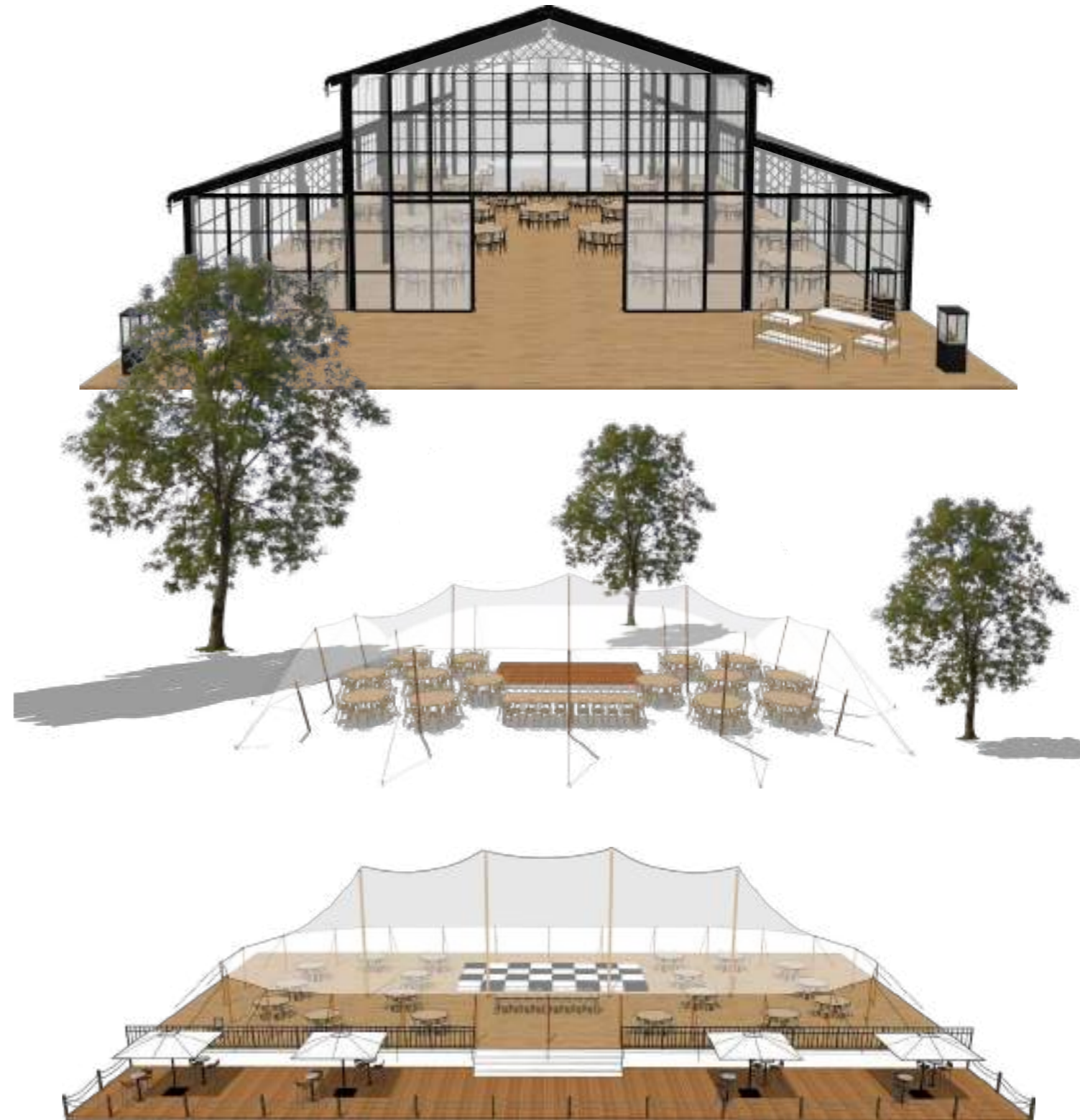
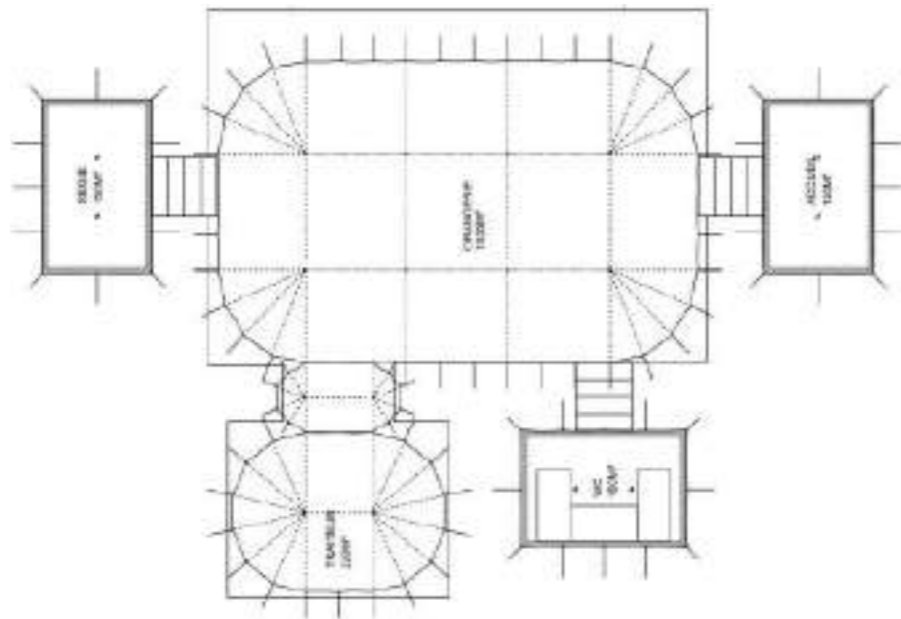



# jfd

ORGANISATION



+33 (0)6 72 53 80 22  
jfd@jfd.fr

f   @   in



jfd.fr